



VT200/220 Weight Indicator Technical Manual AND Protocol



Table of Contents

TABLE OF CONTENTS	II
TABLE OF FIGURES	VI
LEGAL NOTICE	VII
WARRANTY.....	VIII
SAFETY INSTRUCTIONS	IX
DECLARATION OF CONFORMITY	XI
ABOUT THIS DOCUMENT	XII
1 TECHNICAL SPECIFICATIONS.....	14
1.1 GENERAL	14
1.2 ANALOG INPUT	15
1.3 ANALOG OUTPUT (OPTIONAL).....	15
1.4 DIGITAL INPUT	16
1.5 DIGITAL OUTPUTS	16
2 INSTALLATION	17
2.1 SITE REQUIREMENTS	17
2.2 MOUNTING THE INDICATOR	17
2.2.1 Desktop Model (Aluminum Enclosure)	17
2.2.2 Wall-Mount Model (Stainless Steel Enclosure)	18
2.3 CONNECTING LOAD CELLS	19
2.3.1 Desktop Model (Aluminum Enclosure)	19
2.3.2 Wall-Mount Model (Stainless Steel)	20
2.3.3 Load Cell Operating Parameters	20
2.4 SERIAL CONNECTIONS.....	21
2.4.1 Printer and PC Cables	21
2.4.2 RS485 Cable Connections	21
2.5 CONNECTING POWER	22
3 DISPLAY, KEYS AND MENUS.....	23

3.1	THE DISPLAY	23
3.1.1	<i>Status Annunciators</i>	24
3.1.2	<i>Common Messages Shown on the Display</i>	24
3.2	FRONT PANEL KEYS	25
3.2.1	<i>Using Keys to Perform Operations</i>	25
3.2.2	<i>Using Keys to Navigate and Enter Information</i>	26
3.2.3	<i>Editing Multiple Digits</i>	26
3.3	THE FUNCTION MENU	26
3.3.1	<i>Using the Function Menu</i>	27
3.3.2	<i>Function Summary</i>	27
3.4	SETUP MENUS	31
3.4.1	<i>Accessing and Navigating Setup Menus</i>	31
3.4.2	<i>Menu Structure</i>	32
3.4.3	<i>Parameter Summary</i>	32
	<i>SETUP > SETUP 1 (General Operating Parameters)</i>	32
	<i>SETUP > SETUP 2 (Com 1 Settings)</i>	33
	<i>SETUP > SETUP 3 (Com 2 Settings)</i>	34
	<i>SETUP > SETUP 4 (Tilt Switch)</i>	35
	<i>SETUP > SETUP 5 (Setpoints)</i>	35
	<i>SETUP > SETUP 6 (Lock Keys)</i>	36
	<i>ACAL (Analog Output)</i>	37
4	CALIBRATION	38
4.1	CALIBRATION WITH STANDARD WEIGHTS (S-CAL)	38
4.1.1	<i>Zero (Dead-Load) Calibration</i>	38
4.1.2	<i>Span Calibration</i>	39
4.2	ELECTRONIC CALIBRATION (E-CAL)	39
4.2.1	<i>Calculating Calibration Values</i>	40
4.2.2	<i>Setting Zero Calibration (Dead-Load) Value</i>	40
4.2.3	<i>Span (Max. Capacity) Calibration</i>	41
4.3	STORING CALIBRATION DATA	41
4.4	LOCKING AND UNLOCKING CALIBRATION	41
4.4.1	<i>Sealing Indicator Enclosure with Stickers</i>	42

Table of Contents

4.4.2	<i>Securing Load Receptor</i>	44
4.4.3	<i>Checking Seal Status and Audit Trail Counter</i>	44
5	GENERAL SYSTEM PARAMETERS	45
5.1	PAR MENU.....	45
5.1.1	<i>Accessing the Menu and Editing Parameters</i>	45
5.1.2	<i>PAR Menu Parameters</i>	46
5.1.3	<i>Dual-scale Connecting And Parameter Settings</i>	47
5.2	SETUP 1 (INSIDE SETUP MENU)	47
5.2.1	<i>Accessing the Menu and Editing Parameters</i>	47
5.2.2	<i>SETUP 1 Parameters</i>	48
6	SERIAL COMMUNICATION	49
6.1	SERIAL PORTS CONFIGURATION.....	49
6.1.1	<i>RS232 Serial Port</i>	49
6.1.2	<i>RS485 Serial Port</i>	49
6.2	SETTING PORT OUTPUT PARAMETERS	50
6.2.1	<i>Setting Port 1 Output</i>	50
6.2.2	<i>Setting Port 2 Output</i>	50
6.3	OUTPUT TYPES	50
6.3.1	<i>Local Printer</i>	50
6.3.2	<i>Continuous Weight Output</i>	50
	<i>Continuous Weight Data Block Composition LEO Format</i>	51
	<i>Continuous Weight Data Block Composition AND Format</i>	51
	<i>Two-Scale Operation</i>	52
6.3.3	<i>Continuous Weight With Tare</i>	52
	<i>Data Block Composition</i>	53
	<i>When Display Indication is Not Weight</i>	53
6.3.4	<i>Print on Demand</i>	53
6.3.5	<i>Alibi Transmit</i>	54
6.3.6	<i>Alibi Mode Commands</i>	54
	<i>Transmit Displayed Weight</i>	54
	<i>Command "ZERO"</i>	54
	<i>Print on Demand Character</i>	54
6.3.7	<i>EDP Protocol Output</i>	55

<i>Full Protocol Workflow</i>	55
<i>Relevant Setup Parameters</i>	55
<i>EDP Data Block Composition</i>	56
6.3.8 <i>Remote Printer Output</i>	56
6.3.9 <i>Master-Slave Protocol Output</i>	56
<i>Master-Slave Commands</i>	56
<i>Gross-Tare-Net Weight Transmission</i>	58
<i>Tare Presetting via PC</i>	59
<i>Separation of COM1 and COM2 Network Addresses</i>	59
6.4 STANDARD PRINT FORMATS	60
6.5 CUSTOM PRINT FORMATS	61
6.5.1 <i>Creating a Custom Print Format</i>	61
6.5.2 <i>Downloading a Custom Print Format</i>	62
7 OUTPUTS AND DIGITAL INPUT.....	64
7.1 SPECIFICATIONS	64
7.1.1 <i>Digital Outputs</i>	64
7.1.2 <i>Analog Outputs</i>	64
7.1.3 <i>Digital Input (Tilt Switch)</i>	64
7.2 CONNECTING DIGITAL OUTPUTS AND TILT SWITCH	65
7.3 SETTING THRESHOLDS FOR DIGITAL SETPOINTS.....	65
7.4 CONFIGURING ANALOG OUTPUT.....	66
7.4.1 <i>Connecting PCB and Setting Jumper</i>	67
7.4.2 <i>Setting Analog Output Parameters</i>	68
7.4.3 <i>Calibrating D/A Converter</i>	69
7.5 USING THE TILT SWITCH.....	70
7.5.1 <i>Tilt Switch Options</i>	70
8 SERVICE OPERATIONS AND TESTING.....	71
8.1 SERVICE OPERATIONS	71
8.1.1 <i>Setting and Changing Calibration Password (Function 40)</i>	71
8.1.2 <i>Setting Date, Time and Serial Number (Function 05)</i>	71
8.1.3 <i>Displaying Remaining Battery Capacity (Function 02)</i>	72
8.1.4 <i>Checking Calibration Seal (Function 48)</i>	72

Table of Figures

8.1.5 Viewing Load Cell mV (Function 80).....	72
8.1.6 Viewing A/D Count (Function 81)	73
8.1.7 View Software Version Number and Date (Function 82).....	73
8.1.8 Locking and Unlocking Keys	73
8.2 TESTING THE INDICATOR.....	73
8.2.1 Testing ROM/RAM Integrity (Function 86).....	73
8.2.2 Testing the Keypad and Display (Function 90, 91)	74
8.2.3 Testing Digital Input and Outputs (Function 93)	74
8.2.4 Testing the Print Buffer (Function 94)	75
8.2.5 Testing Data Received on Both Serial Ports (Function 96)	75
9 TROUBLESHOOTING.....	76
9.1 ERRORS, CAUSES AND REMEDIES.....	76
9.2 CHECKING LOAD CELL CONNECTION.....	78
9.3 CHECKING POWER SUPPLY	78
9.4 CHECKING DIGITAL OUTPUTS	78
APPENDIX A: TECHNICAL DRAWINGS	79
CONTACTING VISHAY TRANSDUCERS	84

Table of Figures

FIGURE 1 – DESKTOP MODEL, FRONT AND REAR VIEW	17
FIGURE 2 – WALL-MOUNT MODEL, FRONT AND REAR VIEW	18
FIGURE 3 – LOAD CELL CONNECTION DIAGRAM FOR WALL-MOUNT MODEL	19
FIGURE 4 – LOAD CELL CONNECTION DIAGRAM FOR STAINLESS-STEEL MODEL	20
FIGURE 5 – PRINTER AND PC CABLES CONNECTION DIAGRAM	21
FIGURE 6 – RS485 CABLE CONNECTION DIAGRAM.....	22
FIGURE 7 – NON-REMOVABLE STICKER	42
FIGURE 8 – LEAD WIRE SEAL / HARD PLASTIC STICKER	42
FIGURE 9 - WALL MOUNT MODEL, SEALING INSTRUCTIONS.....	42
FIGURE 10 – DESKTOP MODEL, SEALING WITH NON-REMOVABLE STICKER	43
FIGURE 11 – DESKTOP MODEL, SEALING WITH LEAD SEAL / NON-REMOVABLE STICKER	44
FIGURE 12 – DIGITAL OUTPUT AND TILT SWITCH CONNECTION DIAGRAM.....	65

Legal Notice

This manual contains information that is proprietary to Vishay Transducers Ltd. ("VT"). No part of this publication may be reproduced in any form whatsoever without prior written approval by VT.

Right, title and interest, all information, copyrights, patents, know-how, trade secrets and other intellectual property or other proprietary rights relating to this manual and to the VT200 and/or VT220 ("the Product"), and any software components contained therein, are proprietary products of VT protected under international copyright law and shall be and remain solely with VT.

VT200 and VT220 are registered trademarks of VT. No right, license, or interest to such trademark is granted hereunder, and you agree that no such right, license, or interest shall be asserted by you with respect to such trademark.

You shall not copy, reverse compile or reverse assemble all or any portion of the Manual or the Product. You are prohibited from, and shall not, directly or indirectly, develop, market, distribute, license, or sell any product that supports substantially similar functionality as the Product, based on or derived in any way from the Product. Your undertaking in this paragraph shall survive the termination of this Agreement.

This Agreement is effective upon your opening of the packaging of the Product, and shall continue until terminated. VT may terminate this Agreement upon the breach by you of any term hereof. Upon such termination by VT, you agree to return to VT the Product and all copies and portions thereof. For further information contact VT or your local distributor.

Warranty

Vishay Transducers warrants all instruments it manufactures to be free from defect in materials and factory workmanship, and agrees to repair or replace any instrument that fails to perform as specified within one year after date of shipment. Coverage of computers, cameras, rechargeable batteries, and similar items, sold in conjunction with equipment manufactured by Vishay Transducers and bearing the identifying name of another company, is limited under this warranty to one year after the date of shipment. The warranty on non-rechargeable batteries and similar consumable items is limited to the delivery of goods free from defects in materials and factory workmanship.

This warranty shall not apply to any instrument that has been repaired, worked on or altered by persons unauthorized by Vishay Transducers in such a manner as to injure, in our sole judgment, the performance, stability, or reliability of the instrument; subjected to misuse, negligence or accident; or connected, installed, adjusted, or used otherwise than in accordance with the instructions furnished by us.

At no charge, we will repair, at our plant, or an authorized repair station, or at our option, replace any of our products found to be defective under this Warranty.

This Warranty is in lieu of any other warranties, expressed or implied, including any implied warranties of merchantability or fitness for a particular purpose. There are no warranties which extend beyond the description on the face hereof, Purchaser acknowledges that no salesman, agent, employee or other person has made any such presentations or warranties or otherwise assumed for Vishay Transducers any liability in connection with the sale of any goods to the purchase. Buyer hereby waives all rights Buyer may have arising out of any breach of contract or breach of warranty on the part of Vishay Transducers, to any incidental or consequential damages, including but not limited to damages to property, damages for injury to the person, damages for loss of use, loss of time, loss of profits or income, or loss resulting from personal injury.

Some states do not allow the exclusion or limitation of incidental or consequential damages for consumer products, so the above limitations or exclusions may not apply to you.

The Purchaser agrees that the Purchaser is responsible for notifying any subsequent Buyer of goods manufactured by Vishay Transducers of the warranty provisions, limitations, exclusions and disclaimers stated herein, prior to the time any such goods are purchased by such Buyer, and the Purchaser hereby agrees to indemnify and hold Vishay Transducers harmless from any claim asserted against or liability imposed on Vishay Transducers occasioned by the failure of the Purchaser to so notify such Buyer. This provision is not intended to afford subsequent Purchasers any warranties or rights not expressly granted to such subsequent Purchasers under the law.

Vishay Transducers reserves the right to make any changes in the design or construction of its instruments at any time, without incurring any obligation to make any change whatever in units previously delivered. Vishay Transducers' sole liabilities, and Buyer's sole remedies, under this agreement shall be limited to the purchase price, or at our sole discretion, to the repair or replacement of any instrument that proves, upon examination, to be defective, when returned to our factory, transportation prepaid by the Buyer, within the applicable period of time from the date of original shipment. Return transportation charges of repaired or replacement instruments under warranty will be prepaid by Vishay Transducers.

Vishay Transducers is solely a manufacturer and assumes no responsibility of any form for the accuracy or adequacy of any test results, data, or conclusions which may result from the use of its equipment.

The manner in which the equipment is employed and the use to which the data and test results may be put are completely in the hands of the Purchaser. Vishay Transducers shall in no way be liable for damages consequential or incidental to defects in any of its products.

This warranty constitutes the full understanding between the manufacturer and Buyer, and no terms, conditions, understanding or agreement purporting to modify or vary the terms hereof shall be binding unless hereafter made in writing and signed by an authorized official of Vishay Transducers.

Safety Instructions

The following instructions serve as a general guide for the safe operation of the VT200/220. This Technical Manual is intended for users of the Weight Indicator, who are prohibited from installing, calibrating, setting up or servicing the product. Only qualified and authorized service personnel should install the product, set it up, calibrate it, or carry out adjustment, maintenance or repairs.

Safety Symbols



This symbol indicates potential safety hazards regarding product operation or maintenance to operator or service personnel.

General Safety Practices

Do not touch or tamper with the power supply when the power cord is connected. Line voltages may be present even when the product is powered off or a fuse is blown.

Before working on equipment connected to power lines or to other devices, remove jewelry or any other metallic object that may come into contact with energized parts.

The product is intended to be grounded during normal use. Grounding is provided by connecting the mains plug to a wall socket with a protective earth terminal. The earth lug provided on the product should be connected to the protective earth at all times, by a wire with a diameter of 18 AWG or wider.

Always make the ground connection first and disconnect it last. Do not connect data cables to ungrounded equipment. Make sure that all other cables are disconnected before disconnecting the ground.

Special Safety Warnings



Welding on or in the vicinity of the equipment is strictly prohibited.



Use reliable lightning conductors to prevent static loads caused by thunderstorms.

Connection of AC Mains

Make sure that the electrical installation complies with local codes. Always connect the AC plug to a wall socket with a protective ground.

The maximum permissible current capability of the branch distribution circuit that supplies power to the product is 16A. The circuit breaker in the building installation should have high breaking capacity and must operate at short-circuit current exceeding 35A.

Always connect the power cord first to the equipment and then to the wall socket. If the power cord cannot be readily disconnected in case of emergency, make sure that a readily accessible circuit breaker or emergency switch is installed in the building.

Operating Environment

Ambient Temperature	Storage temperature: -10C to +70C (14F to 158F). Operating temperature: -10C to +40C (14F to 104F).
Humidity	40% to 90% RH (non condensing).
Vibration	Severe vibration can affect the accuracy of weighing and damage components.
Air	The air surrounding the product should be dust-free and should not contain corrosive gasses or other materials that could adversely effect the product.
Electromagnetic Fields	Heavy electrical equipment should not be installed near to the weighing apparatus.
Incoming and Outgoing Signals	Relays and contacts connected to the equipment must have reliable and effective interference suppression. This also applies to other equipment within 3 meters of the equipment.

Declaration of Conformity

Non-Automatic Weighing Instrument (III)

Manufacturer	VISHAY Transducers
---------------------	--------------------

Type/Model	VT200, VT220
-------------------	--------------

EC Type Approval Certificate Number	DK 0199.62
--	------------

Corresponds to the production model described in the EC Type Approval Certificate and to the requirements of the Council Directive 90/384/EEC as amended and to the requirements of the following EC Directives:

EN 45501:1994, The Metrological Aspects of Non-Automatic Weighing Machines.

EN 55022:1987, Limits and Methods of Measurement of Radio Interference Characteristics of Information Technology Equipment.

EN 60950:1992, Safety of Information Technology Equipment.

Date	April 30, 2004
-------------	----------------

Signature	Benny Shaya, Director R&D/Operations Instruments Being the responsible person employed and appointed by Vishay Transducers.
------------------	--

About this Document

This document provides technical information for the VT200/220 Weight Indicator. It is intended for technical staff tasked with installing, setting up and configuring the indicator, as well as troubleshooting and servicing.

For information on how to use the products, see the *VT200/220 User's Guide*.

Chapters and Their Contents

1	Technical Specifications	General indicator specifications; analog input/output specs; and digital input/output specs.	Pg. 13
2	Installation	Installing and connecting the indicator.	Pg. 16
3	Display, Keys and Menus	Using the VT200/220 display, keypad, function menu and setup menus.	Pg. 20
4	Calibration	Performing standard weight calibration and electronic calibration.	Pg. 28
5	Setting Operating Parameters	General parameters in the SETUP 1 and PAR menus.	Pg. 33
6	Setting up Serial Communication	Setting up communication with printers, host PCs and other external devices.	Pg. 38
7	Outputs and Digital Input	Connecting and using the digital input (tilt switch), digital outputs (setpoints) and analog output.	Pg. 45
8	Service Operations and Testing	How to set a PIN number, set date and time, view load cell mV, test the keypad and display, and perform other service and testing operations.	Pg. 47
9	Troubleshooting and Service	Errors, causes and suggested corrective actions; maintenance and service instructions.	Pg. 50

Style Conventions

Verdana Regular text.

Arial Bold Commands, keys and other parts of the user interface.

Arial Italics Names of classes, methods, arguments, exceptions, properties, etc. Also used for special terms, the first time they appear.

Monospace Text displayed on the LCD or on a computer attached to the product.



Notes, which offer an additional explanation or a hint on how to overcome a common problem.



Warnings, which indicate potential safety hazards regarding product operation or maintenance to operator or service personnel.

1 Technical Specifications

1.1 General

CPU Characteristics	MCU 89C51RD, 64KB Flash ROM, 1KB RAM, 32KB serial EEPROM. CPU real time clock is optional.
Communication	<ul style="list-style-type: none"> Serial port 1: RS232C Full duplex, 1200-9600 baud rate, 8 data bits/no parity or 7 data bits/odd or even parity. Printer, weight output. Serial port 2: (optional): RS232 or RS485 half duplex, 2400-57600 baud rate, 8 data bits/even or no parity or 7 data bits/even parity. <p>Master/slave protocol, EDP output, selectable weight output.</p>
Display	<ul style="list-style-type: none"> VT200: 6 digit ,7 segment red LED (20mm height) display. VT220: Black LCD (16mm height) display.
Annunciators	Net, No Motion, Minus sign, Zero, Range 1 and 2.
Keyboard	8-key membrane type with tactile feedback.
Approvals	EU type approval 10,000 divisions, DK 0199.62.
Accuracy class	III.
Resolution	Selectable up to 99,000 dd (in accordance with regulations).
Max tare effect	Full scale (100%).
Auto Zero track	Off or 0.5 dd, setup-selectable.
Weight digits	4, 5 or 6.
Weight steps	1, 2, 5, 10, 20, 50, 100, 200.
Digital filter	FIR automatically adjusted to conversion speed, plus post filtering (rolling average of 1, 2, 4, 8, 16, 32 samples).
Calibration methods	Dead load, span and scale parameters via keyboard commands. Calibration can be performed either by weighing or by entering load cell mV values.
Self diagnostics	Hardware and software – MCU watchdog. Memory failure and I/O failure – program check.

1.2 Analog Input



A second analog input may be added as an option, if no analog output is needed. The same specifications apply. Second analog input is not supporting continuous weight output AND format see 6.3.2

Load cell excitation	±5V switched polarity or +5VDC with sense.
Connection	6-wire technique. Max 10 load cells 350 Ohm each.
Signal range	-0.25 to 1.75mV/V (Gain=10), -0.25 to 3.75mV/V (Gain=20).
Sensitivity	<ul style="list-style-type: none"> • Approved scales: min 0.4µV / digit (VSI). • Non-approved scaled: min 0.1µV / digit.
Input amplifier	Input noise 0.3µVp-p, input bias current 10nA typical.
A/D Converter	Sigma delta 550,000 internal counts max. Conversion speed: 3, 7, 14, 28, 57, 70Hz (selectable).
Linearity	Within 0.002% of full scale.
Span temp coefficient	≤2ppm/°C.
Zero temp coefficient	≤2ppm/°C.
Long-term stability	0.005% of full scale per year.

1.3 Analog Output (Optional)



If no second analog input (See 1.2 above) is needed, an analog output may be added. Analog Output is powered by an external 24VDC (See section 7.1.2 for specification).

Current or voltage	Selected via jumper JP1 on printed circuit board 761 (see section 7.4).
Current output	0-20 mA or 4-20 mA. Max load resistance 1KΩ (line + termination).
Voltage output	0.02-10V. Min load resistance 1KΩ.
Resolution	<ul style="list-style-type: none"> • Internal: 16 bits. • External: 16 bits, or in accordance with regulation.
Linearity	Better than 0.01% of FSR.
Thermal stability	50ppm/°C typical.
Short-circuit protection	25mA indefinite duration.

Technical Specifications

Digital Input

1.4 Digital Input

Input voltage	9-24VDC, positive common, optoisolated to 2.5KV.
Input resistance	3.3K Ω .
On delay	2msec max.
Off delay	2msec max.

1.5 Digital Outputs

Output voltage	24VDC \pm 10% transistor (SOURCE) darlington, positive common.
Max current	100mA, leakage current 100 μ A.
Max off-state voltage	30VDC.
On delay	2msec max.
Off delay	2msec.

2 Installation

2.1 Site Requirements

The mounting location must be a stable surface, free of vibrations, heat or humidity. Avoid direct sunlight on the front of the instrument. The unit should be placed at the correct height to allow easy reading of the display and convenient keyboard operation.

2.2 Mounting the Indicator

2.2.1 Desktop Model (Aluminum Enclosure)

Front and rear views of the unit are shown in Figure 1.



Figure 1 – Desktop model, front and rear view

Installation

Mounting the Indicator

All connections to the instrument are made through the rear panel connectors. Strain-relief clamps should be used. The shield should be connected to the metal frame of the connector.

2.2.2 Wall-Mount Model (Stainless Steel Enclosure)

Front and rear views of the unit are shown in Figure 2.



Figure 2 – Wall-mount model, front and rear view

➔ To connect the indicator to the stainless steel wall-mount:

1. Remove the rear panel and lift it carefully.
2. Insert the cables via the cable glands. Strip and connect the cables according to the schematic diagram in Appendix A.
3. Connect the cable shield between the plastic part and the metal case of the cable glands, or to the screws supporting the PCBs.
4. Re-install the rear panel.

2.3 Connecting Load Cells

2.3.1 Desktop Model (Aluminum Enclosure)

Use 6 x 0.5mm² shielded cable for load cell connections. Connect the load cells according to the diagram below.

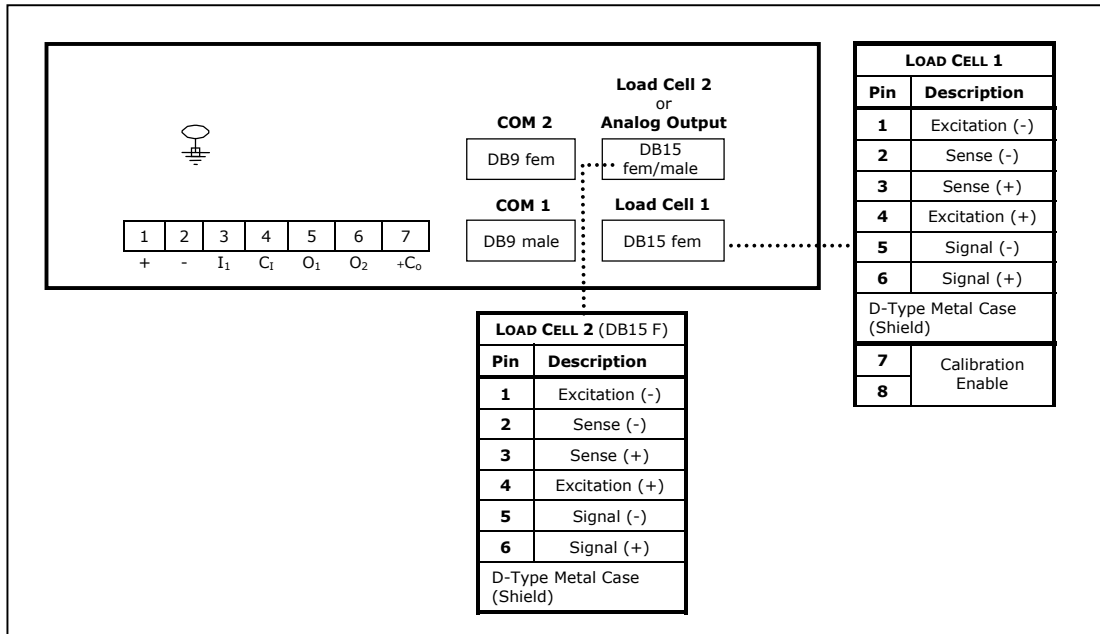

Figure 3 – Load cell connection diagram for wall-mount model

Installation

Connecting Load Cells

2.3.2 Wall-Mount Model (Stainless Steel)

Use 6 x 0.5 mm² shielded cable for load cell connections. Connect the load cells according to the diagram below.

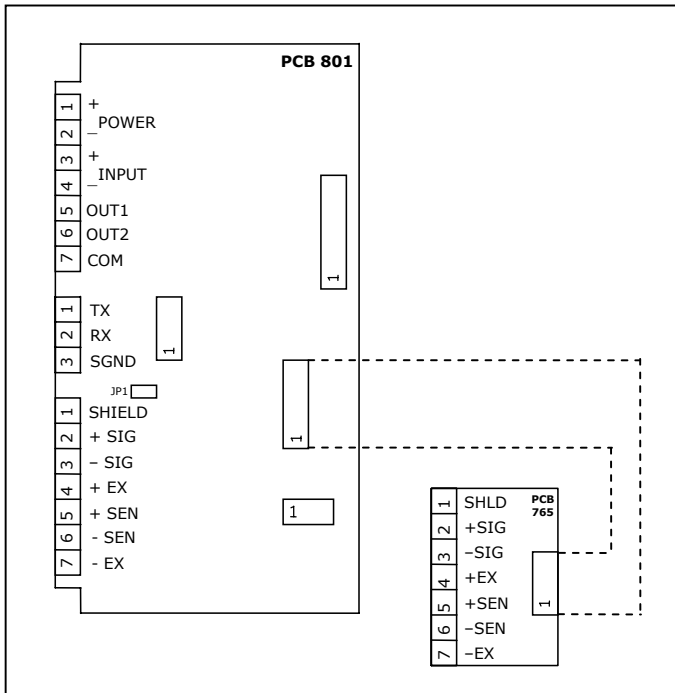

Figure 4 – Load cell connection diagram for stainless-steel model

2.3.3 Load Cell Operating Parameters

The load cell utilization ranges are listed in the table below.

Excitation	5VDC, fixed or alternating polarity (SETUP selectable) for 10 load cells of 350Ω each.
Gain / input ranges	<ul style="list-style-type: none">• For load cell output of 10mV, gain permitted is between -0.25 and 1.75mV/V.• For load cell output of 20mV, gain permitted is between -0.25 and 3.75mV/V. <p>The load cells must be chosen so that the input signal to the controller is at least 0.4μV per scale increment. For load cell output less than 0.4μV/digit, the controller will still be stable but the full temperature range accuracy is not guaranteed.</p>



Do not run signal cables together with power cables. Connect the shielding only where indicated in the drawing. Never use a Megger to check wiring. Never use plastic insulating tape on load cell connections.

2.4 Serial Connections

- For RS232C connection, use 3 x 0.34 mm² shielded cable.
- For RS485 connection, use 2 x 0.34 mm² shielded twisted pair cable.

2.4.1 Printer and PC Cables

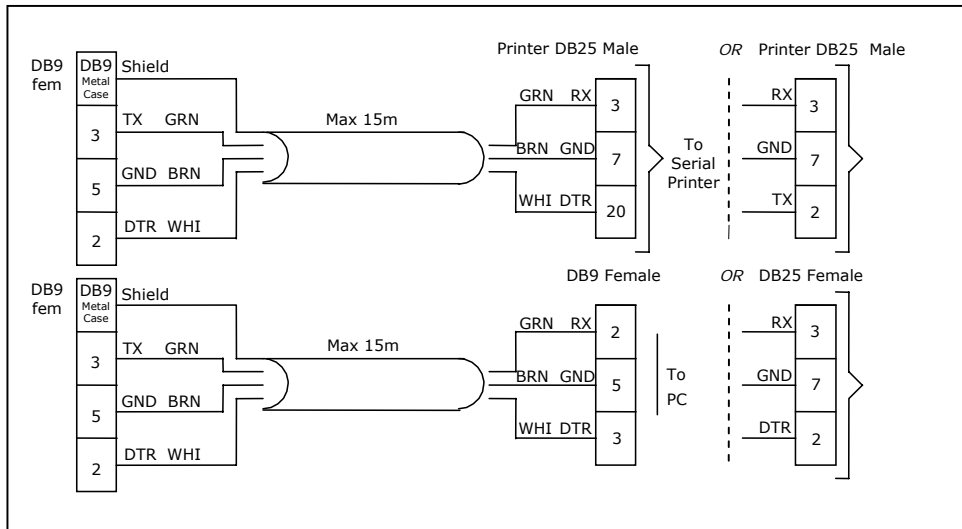

Figure 5 – Printer and PC cables connection diagram



Only the aluminum enclosure has a DB9 connector. The steel enclosure has a screw terminal on the internal card, to which you should attach the individual wires.

2.4.2 RS485 Cable Connections

The terminal block on the RS485 board enables connecting two pairs of wires (A, B):

- One wire pair for connecting the incoming cable.
- A second wire pair for a daisy-chain connection to the next unit on the RS485 bus.

Installation

Connecting Power

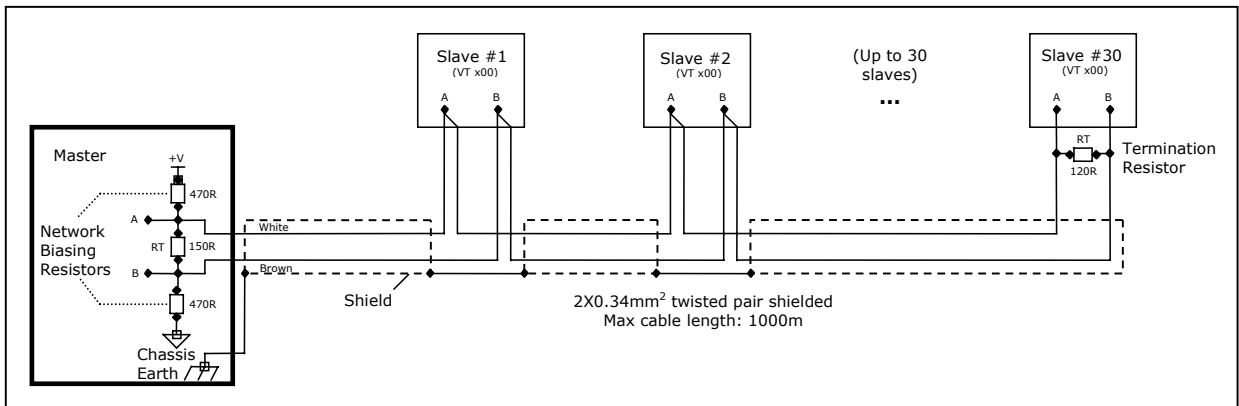

Figure 6 – RS485 cable connection diagram

2.5 Connecting Power

VT200/220 indicators are powered from 85-265 VAC, via internal power supply board. The mains power cable is supplied with the instrument.

Power should be isolated from other data processing equipment.

Verify that the AC power socket outlet is properly protected. For optimum EMC performance, keep the length of cable shielding inside the enclosure as short as possible.

3 Display, Keys and Menus

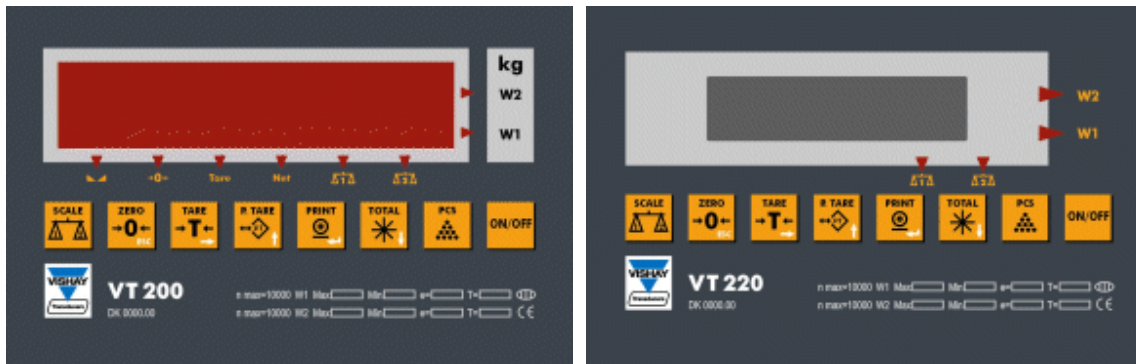

The VT200/220 front panel can be divided into three areas:

- A six-digit display (LED for VT200, LCD for VT220) that shows weight information, status information, and the names of menus and functions.
- A keypad with eight keys, allows you to turn the unit on and off, perform the most common functions, and access a function menu with more advanced options.
- The lower area shows information about the maker, model and certified limits of your indicator.

3.1 The Display

The VT200 has an LED display, while VT220 model has an LCD display. Both models have six digits, used mainly to display weight information.







To the bottom and right of the digits, small dots may appear next to distinctly-shaped *status annunciators*. These dots provide status information, such as whether the scale has been tared or not.

Display, Keys and Menus

The Display





3.1.1 Status Annunciators

At the bottom and right of the display are several status annunciators. A dot or a light shows up next to these to indicate the current status of the scale or indicator. Status annunciators are often important to understand what is being shown on the display.

	Stable	Active – the scale is stable (necessary for ZERO , TARE and PRINT). Inactive – the scale is not stable.
	Center of Zero	Active – the current weight is at center of zero. Inactive – the scale is above or below center of zero.
	Tared	Active – the preset tare value is now being displayed on the screen.
	Net Weight	Active – the display is showing net weight. Inactive – the display is showing gross weight.
	Scale 1 only	Active – the indicator is set to scale 1. All operations relate to scale 1.*
	Scale 2 only	Active – the indicator is set to scale 2. All operations relate to scale 2.*
	Scale 1 and Scale 2	Active (both) – the indicator is set to the two scales combined. All operations relate to the sum of the two weights.*
	W1	The scale is currently in weight range 1.
	W2	The scale is currently in weight range 2.

* These are not relevant if you only have one scale connected to the indicator.

3.1.2 Common Messages Shown on the Display

Message Type	Meaning
352.0	Weight of the item on the scale.
24509	Number of units on the scale.
319.0 ( active)	Net weight , or number of units calculated after subtracting the container's weight.
nnnnnn	Over range. The item on the scale weighs more than the maximum capacity of the scale, or the load cell signal is too high.
UUUUUU	Under range. The item on the scale weighs less than the minimum capacity of the scale, or the load cell signal is too low.
Fn 06	Function menu (see chapter 2). To perform the function currently showing, press PRINT (). To cancel press ZERO ()
Err15	An error has occurred (see chapter 9). In some cases, you can ignore the error and continue working by pressing ZERO ()
XXXXXX	Software model number , shown during the power-up sequence.
XXXXXX	Software version issue date , shown during the power-up sequence.
888888	Display self-test , performed during the power-up sequence.

ZeRO Automatic or manual zeroing is being performed.







Other types of messages may be shown when you perform specific operations, such as editing the tare value or displaying battery status.

3.2 Front Panel Keys

The keys on the front panel serve two functions:





- Performing operations, indicated in black at the center of the key.
- Navigating menus and entering numeric information. Each key's navigation function is indicated in white at its bottom-right corner.

3.2.1 Using Keys to Perform Operations

Key	Description	Related operations
	Toggles between scale 1, scale 2 and the sum of both scales (if two scales are connected).	Two-scale operation
	Press once to tare the scale*. Press again to view gross weight.	Taring using current weight
	Press to manually enter a tare value. Use ↑ (P.TARE) to change the current digit, then → (TARE) to move to the next digit. When you are done, press ← (PRINT). To cancel and view gross weight, press ZERO.	Taring by entering weight
	When you press this key, the current weight* is printed to the printer and/or output to an attached computer, and added to the accumulated <i>total</i> .	Printing, outputting to computer
	Press once to view the sum of all accumulated weights. Press again to see the number of weights accumulated. Press again to view the current weight.	Accumulated total
	Press to switch between Weighing Mode and Counting Mode. Counting Mode shows the number of units on the scale. Weighing Mode shows weight.	Counting pieces, weighing
	Press to turn the indicator on, or to switch it off when it is running.	Starting the indicator

* This operation cannot be performed if the weight is not stable.

3.2.2 Using Keys to Navigate and Enter Information

Key	Description
	Escape. Cancels the current operation, exits a menu or cancels tare (if active).
	Next. When editing multiple digits, moves to the next digit. Only press this key once you have finished editing the current (flashing) digit. Function menu. Press this key for three seconds to access the function menu.
	Up. Increments (adds one) to the current digit, or moves to the previous menu option in setup.
	Enter. Confirms the current operation or the information entered.
	Down. Moves to the next menu option in setup.

3.2.3 Editing Multiple Digits

➔ **To edit multiple digits shown on the display:**

1. Take note of the flashing digit. This is the digit you are currently editing. Press ↑ (**P.TARE**) to increment this digit, until it shows the number you need.
2. Press → (**TARE**) to move to the next digit on the right. It should start flashing.
3. Press ↑ (**P.TARE**) to increment the flashing digit, until it shows the number you need.
4. Repeat steps 2 and 3 until you have edited the last digit.
5. Press ← (**PRINT**) to confirm the number you entered.

3.3 The Function Menu

The function menu allows you to perform advanced operations like high-resolution weighing, selecting printing format and viewing alibi memory.

It is accessed by pressing the **TARE** () button for three seconds, while in Weighing Mode (you cannot access the function menu from Counting Mode).

This subchapter explains how to use the menu and provides a summary of its functions. All operations are explained in more detail further in this document.

3.3.1 Using the Function Menu

➔ **To access a function on the function menu:**



1. Press **TARE** () on the front panel, and keep it pressed for around three seconds. The display shows `Fn 00`. The left digit should be flashing.
2. Check the number of the function you need (refer to Function Summary list below). If the function you need is between 01 and 09, skip to step 4.
3. Press **↑ (P.TARE)** to increment the left-hand digit (tens). Keep pressing it until it matches the function you need. For example, if you need function 43, press **↑** four times. The left digit should become 4.
4. Press **→ (TARE)** to move to the right-hand digit (units). This digit should start flashing.
5. Press **↑ (P.TARE)** to increment the right-hand digit (tens). Keep pressing it until it matches the function you need. For example, if you need function 43, press **↑** three times. Assuming you entered 4 for the left-hand digit, the display should now show `Fn 43`.
6. Press **↵(PRINT)** to confirm. The operation associated with the function number you entered is performed.



3.3.2 Function Summary

Function	Description	Refer to
01	<p>Edit setpoints. The display shows <code>SETP 1</code> briefly, then the current setpoint value.</p> <p>Use ↑ (P.TARE) to change the current digit, then → (TARE) to move to the next digit.</p> <p>When you are done, press ↵(PRINT).</p> <p>The display shows <code>SETP 2</code> briefly, then the current setpoint value.</p> <p>Edit the second setpoint value using the same procedure.</p>	Chapter 7
02	<p>Display battery status. The display shows the current battery charge, as a percentage of total capacity.</p>	

Display, Keys and Menus

The Function Menu

Function	Description	Refer to
05	<p>Set date, time and serial number. A battery-backed RAM and the Real Time Clock (RTC) option need to be installed to enable setting time.</p> <p>This function depends on the setup parameter 1.6 (1=enabled; 0=disabled). The date format is specified in setup parameter 1.4 (DDMMYY or MMDDYY).</p> <p>Use ↑ (P.TARE) to change the current digit, then → (TARE) to move to the next digit. When you are done, press ↵ (PRINT).</p> <p>The display now shows HHmmSS (hours, minutes, seconds); edit the current time and confirm.</p> <p>The display shows the current alibi memory serial number, also used on the printed ticket. You can edit this number, then press ↵ (PRINT).</p>	
06	<p>High resolution weighing. Increases the accuracy of the displayed weight by a factor of ten, the smallest item is limited to 1 display division.</p> <p>When this function is enabled, the display flashes and you may not print.</p> <p>Press ZERO () to cancel and return to normal resolution.</p>	User's Guide, section 4.6
20	<p>Disable printer output. Prevents the indicator from printing when you press PRINT () , even if a printer is connected.</p>	
21	<p>Set print format: Ticket. Shows date, time and weight, as follows:</p> <pre>07-10-02 00:00:00 N:00001 GROSS:<00.500 kg></pre>	Section 6.4
22	<p>Set print format: Continuous output. Used for external display or PC.</p> <p>There are 2 continuous output formats LEO and AND see 6.3.2</p>	Section 6.4
23	<p>Set print format: Net/gross. Shows either net or gross weight, depending what is shown on the display.</p> <pre>Gross weight: GROSS: <00.500 kg> Net weight: NET: <01.000 kg></pre>	Section 6.4
24	<p>Set print format: 3-line detailed weight. Shows gross, tare and net weight in three separate lines as follows:</p> <pre>GROSS : 01.100 kg TARE : 00.100 kg NET : <01.000 kg></pre>	Section 6.4
25	<p>Set print format: 3-line detailed weight large. Same as function 24, except the information is printed in quadruple-size characters.</p>	Section 6.4

Function	Description	Refer to
26	<p>Set print format: 1-line detailed weight. Shows serial number, gross, tare and net in one line as follows:</p> <p>00002 01.100kgG 00.100kgT 01.000kgN</p>	Section 6.4
27	<p>Set print format: Displayed weight. The weight is shown on the display (regardless of mode).</p>	Section 6.4
28	<p>Set print format: 1-line weight and serial.</p> <p>00001 00.500 kg</p>	Section 6.4
29	<p>Set print format: On demand. Weight data (either net or gross, depending what is shown on the display) is transmitted every time a character (set in setup parameter 3.t) is received from a connected peripheral. The format is as follows:</p> <p>Gross weight: GROSS:<00.500 kg></p> <p>Net weight: NET:<01.000 kg></p>	Section 6.4
30	<p>Set print format: Label. Prints a label showing gross weight, tare and net weight. The format is as follows:</p> <p>GROSS TARE NET</p> <p>00.500kg 00.100kg 01.000kg</p>	Section 6.4
40	<p>Changing PIN. Used to change the current Personal Identification Number that enables access to the calibration procedure.</p>	Chapter 8
41	<p>Download custom print format 1. Downloads a custom print format from a PC. Suitable for operations in gross mode.</p>	Section 6.5.1
42	<p>Download custom print format 2. Downloads a custom print format from a PC. Suitable for operations in Tare mode.</p>	Section 6.5.2
43	<p>Repeat last printout. Prints an exact copy of the last printout.</p>	User's Guide, section 6.1.1
48	<p>Check calibration seal. Shows the calibration counter, and the status of the physical calibration seal (if used).</p>	
49	<p>Setup and calibration.</p>	Chapter 4
50	<p>Piece count. Switches between Counting Mode and Weighing Mode. Same as pressing Pcs ()</p>	User's Guide, chapter 5
51	<p>Set unit weight for counting, by weighing. The display shows xx. Enter the number of units currently on the scale and press PRINT ()</p> <p>The indicator records the average unit weight and uses it for counting.</p>	User's Guide, section 5.2

Display, Keys and Menus

The Function Menu

Function	Description	Refer to
52	<p>Set unit weight for counting, by entering weight.</p> <p>The display shows xxxxxx. Enter a unit weight , using ↑ (P.TARE) to change the current digit, then → (TARE) to move to the next digit.</p> <p>When you are done, press ↵(PRINT). The display shows the number of units on the scale, using the new unit weight.</p>	User's Guide, section 5.3
53	<p>Set unit weight by weighing sample, and view unit weight.</p> <p>The display shows xx. Enter the number of units currently on the scale and press PRINT (PRINT). The average unit weight is shown on the display.</p> <p>The indicator records the average unit weight and uses it for counting.</p>	User's Guide, section 5.2
55	<p>View an alibi memory record/print ten records.</p> <p>Set setup parameter 2.t to 13 to enable Alibi printing.</p> <p>Press ↵(PRINT). The display shows n 0000 (the Alibi serial number).</p> <p>Choose the required Alibi number . To view the gross weight of an Alibi record, press ↵(PRINT).</p> <p>When you are done, press ↵(PRINT). The display shows the memory record you requested. If you want to print this and the next nine records, press ↵(PRINT) again.</p>	Users Guide, section 7.1
56	<p>Print all alibi memory records. Prints the entire contents of alibi memory, including empty or corrupted locations.</p> <p>Set setup parameter 2.t to 13 to enable Alibi printing.</p> <p>The entire alibi memory will be printed in the format (gross weight):</p> <p>SN 0001 123.45</p> <p>Press ZERO (ZERO) to stop printing.</p>	Users Guide, section 7.2
57	<p>Checksum Test. Performs a checksum on each alibi memory, ensuring it is not corrupted. An alibi memory serial number will be displayed in the format n 0000.</p> <p>If all records are okay, PASS is displayed briefly. If an error is found, Err 57 is displayed.</p> <p>Press ZERO (ZERO) to cancel the operation midway.</p>	
80	<p>Load-cell mV meter. The actual mV output of the scale sensors is displayed.</p>	Chapter 8
81	<p>Display internal A/D count. The analog-to-digital converter internal count is displayed.</p>	Chapter 8
82	<p>Display version and date.</p>	Chapter 8





Function	Description	Refer to
85	Analog output test.	Chapter 8
86	ROM - RAM test. A validity check is performed on system ROM and RAM.	Chapter 8
90	Display segment test. All digits go through 0-9 display routine in sequence, after which the character set is displayed.	Chapter 8
91	Keyboard test. Display blanks. The scan code of any key pressed is shown on the display.	Chapter 8
93	Setpoint input/output test. The display shows the status of the digital input and outputs.	Chapter 8
94	Print buffer test. An ASCII file (30h-7Fh) is output to the printer port with error control.	Chapter 8
96	Display characters received by COM ports. Any character received by COM 1 is echoed and displayed in ASCII hex on digits 1 and 2. Any character received by COM 2 is echoed and displayed in ASCII hex on digits 5 and 6.	Chapter 8

3.4 Setup Menus

3.4.1 Accessing and Navigating Setup Menus

To enter the setup and calibration menus, either execute function 49, or follow the procedure below.

➔ **To enter the setup and calibration menus:**

1. Turn on the unit.
2. During the self-test routine, while all display segments are on (all 8 on the display), press **PRINT** () momentarily, followed by **TARE** () momentarily.
3. If the PIN code is activated, the display shows **ACCESS** briefly. Type the PIN and then press **PRINT** () to get into the calibration menu. The display shows **SETUP**.
4. Use **TOTAL** () to step through the menus.



The menus displayed depend on whether jumper JP1 is in the sealed position or not (see section 4.4). If it is sealed, the following menus are hidden: **Par**, **CAL**, **INIT** and **A-CAL**.

5. To enter a menu, press **PRINT** ()

3.4.2 Menu Structure

Main menu	Submenu	Description
SETUP	SETUP 1	General scale parameters.
	SETUP 2	Serial port 1 parameters.
	SETUP 3	Serial port 2 parameters.
	SETUP 4	Tilt Switch parameters.
	SETUP 5	Setpoint parameters.
	SETUP 6	Lock keys.
Par	0.P, 1.P, 2.P, 3.P, 4.P, 5.P, 6.P, 7.P	General scale parameters with multiple values.
	8.1, 8.2, 8.3, 8.4, 8.5, 8.6, 8.7, 8.8, 8.9, 8.A, 8.b	General scale parameters with two possible values.
CAL	S-CAL (ZEro, SPAN)	Standard-weights calibration dialog.
	E-CAL (ZEro, SPAN)	Electronic calibration dialog.
STORE	-	Permanently saves calibration data and exits setup.
INIT	-	Resets scale parameters, configuration and calibration data to manufacturer defaults.
A-CAL	A.1, A.2, A.3, A.4, A.5, A.6, A.7, A.8	D/A analog output parameters.

3.4.3 Parameter Summary

SETUP > SETUP 1 (General Operating Parameters)

Par.	Description	Values
1.1	Enable totalizer. YES enables the totalizer. NO disables it.	0=NO 1=YES
1.4	Date format. Sets the date format in all printing formats.	0=d-m-y 1=m-d-y
1.6	Enable real-time clock and battery-backed RAM (optional). If the battery-backed RAM option is installed, this parameter enables saving date, time and the accumulated total in persistent memory. You must enable this parameter to be able to set date and time.	0=NO 1=YES
1.8	Enable function menu. YES specifies that users can access the function menu by pressing TARE for 3 seconds. NO specifies that users should not be able to access the function menu.	0=NO 1=YES

Par.	Description	Values
1.t	Auto power off. Time for the unit to switch off if the scale is zero.	00 - 99 minutes 00=Disabled
1.E	Number of samples in counting.	5 - 99

SETUP > SETUP 2 (Com 1 Settings)

Par	Description	Values
2.t	Print type. Selects current print format from ten default formats and two custom formats, or disables printer port.	00=port disabled; 01=ticket; 02=weight output; 03=single line; 04=ticket; 05=ticket; 06=single line; 07=weight; 08=serial and weight; 09=demand; 10=label; 13=alibi memory; 20=custom print formats (see section 6.5); 22=continuous weight output w/dual scale
2.c	Master/Slave protocol address.	60-90
2.C	Print-on-demand character.	65-90
2.L	Page length. Ticket length, in linefeeds.	
2.r	Paper reverse. Number of reverse linefeeds before printout.	
2.A	Left margin. Number of spaces from left margin.	
2.F	Page header. Number of linefeeds before printout.	
2.E	Line termination.	0=LF 1=CRLF 2=LFCR
2.1	Printer model.	0=FANFOLD(like Epson EP-FX or similar serial printer) 1=SLIP(like Epson TM-295)
2.2	Continuous weight output format	LEO or AND
2.3	Print below minimum capacity.	0=NO 1=YES
2.4	(Reserved for future use)	
2.5	(Reserved for future use)	
2.6	Wait unload.	0=NO 1=YES
2.7	Printer error control. Set to 0 for communication with a PC.	0=NO 1=YES

Display, Keys and Menus

Setup Menus

Par	Description	Values
2.8	Operator print type change (Fn 20-30).	0=NO 1=YES
2.d	Data bits/Parity serial channel 1	N8 = 8 Data bits/no parity, 07 = 7 Data bits/odd parity, E7 = 7 Data bits/even parity,
2.11	1 line with date, time and indicated weight 07-10-03 15:25:20 00500kgG	0=NO 1=YES
2.b	Baud rate serial channel 1.	12= 1200 bps 24= 2400 bps 48 = 4800 bps 96 = 9600 bps



Above **2.2**, **2.b** and **2.d** settings only suitable to set **2.t=0.2** for Continuous Weight Output.

SETUP > SETUP 3 (Com 2 Settings)

Par.	Description	Values
3.t	Instrument communication type.	00=disabled; 01 =continuous weight output; 02=EDP protocol output; 03=printer protocol output; 06=continuous weight w/tare output; 11=continuous output with dual scale; 65-89=master/slave protocol address
3.1	Timeout control.	0=NO 1=YES
3.2	Handshake.	0=NO 1=YES
3.3	Operator disable.	0=NO 1=YES
3.4	Host enquiry.	0=NO 1=YES
3.5	Remote keyboard commands.	0=NO 1=YES
3.6	Continuous weight output format	LEO or AND
3.7	(Reserved for future use)	
3.8	Debug.	0=NO 1=YES
3.b	Baud rate serial number 2.	24 = 2400 bps 96 = 9600 bps 19 = 19200 bps 38 = 38400 bps 57 = 57600 bps

3.d	Data bits serial channel 2.	17 = 7 data bits / even parity 08 = 8 data bits / no parity 18 = 8 data bits / even parity
-----	------------------------------------	--

SETUP > SETUP 4 (Tilt Switch)

Par.	Description	Values
4.t	Time delay, after closing the contact, for the display to lock. This is also the time for the display to unlock after the contact is opened. This parameter allows several special options, accessed by setting it above 90:	00=disabled 01-90 (x 0.1 sec) 91-96=special options
	<ul style="list-style-type: none"> • 91 – Tare scale on the rising edge of input. Setpoints always enabled. • 92 – Print on the rising edge of the input. Setpoints always enabled. • 93 – Setpoints active when input is high. Setpoints inactive when input is low. • 94 – Scale is tared at the rising edge of input. If taring is successful, setpoints are activated. If input is low, setpoints are inactive. • 95 – When input is low, scale 1 is selected and displayed. When input is high, scale 2 is selected and displayed. • 96 – Scale is zeroed. 	

SETUP > SETUP 5 (Setpoints)

Par.	Description	Values
5.1, 5.2	Setpoint 1 output.	5.1=0 and 5.2=0: normal 5.1=1 and 5.2=0: no motion 5.1=0 and 5.2=1: error
5.3, 5.4	Setpoint 2 output.	5.3=0 and 5.4=0: normal 5.3=1 and 5.4=0: zero 5.3=0 and 5.4=1: net
5.6	Net / gross for both setpoints.	0 = net 1 = gross
5.7	Normally open / closed for both setpoints.	0 = normally open 1 = normally closed

Display, Keys and Menus

Setup Menus

SETUP > SETUP 6 (Lock Keys)

Par.	Description	Values
6.1	SCALE key.	1=lock 0=unlock
6.2	ZERO key.	1=lock 0=unlock
6.3	TARE key	1=lock 0=unlock
6.4	PRESET key.	1=lock 0=unlock
6.5	PRINT key.	1=lock 0=unlock
6.6	TOTAL key.	1=lock 0=unlock
6.7	PCS key.	1=lock 0=unlock
6.8	(Reserved for future use)	

ACAL (Analog Output)

Par.	Description	Values
A.1	<p>Standard / custom zero and span.</p> <p>0 specifies that the scale should output 0 mA at zero input and 20mA at maximum input (or 0V at zero and 10V at max).</p> <p>1 opens a dialog, after A.8, that allows you to enter custom zero and span values. Press PRINT to confirm; the display shows 0 xx.xxx. Enter the D/A output at zero, in voltage or mA, and press PRINT. The display shows F xx.xxxx. Enter the D/A output at maximum input, in voltage or mA, and press PRINT.</p>	<p>0 = Standard (20 mA max)</p> <p>1 = User defined Zero and Span</p>
A.2	<p>Normal or absolute AOUT mode. Specifies what happens when the displayed weight is negative: analog output is either zero (normal mode) or the absolute value of the negative reading (absolute mode). For example, if the display shows -100.00, and absolute mode is set, AOUT=10mA. In normal mode, AOUT=0mA, regardless of the negative reading.</p>	<p>0= Normal</p> <p>1 = Absolute</p>
A.3	<p>Error output level. Specifies whether scale errors should be indicated as a low or high signal.</p>	<p>0 = Low (0 mA)</p> <p>1 = High (24 mA)</p>
A.4	<p>Current / voltage. This parameter must correspond to the hardware jumper, which defines whether output should be in current or voltage (see section 7.4.1).</p>	<p>0 = Current</p> <p>1 = Voltage</p>
A.5	<p>Net / gross. Specifies whether the indicator should always output gross weight, or output net weight when tare is active.</p>	<p>0 = Net weight</p> <p>1 = Gross weight</p>
A.6	<p>Effective range for current output. Sets the range to 0-20mA or 4-20mA. Relevant only if A.4 and the hardware jumper are set to current.</p>	<p>0 = 0-20 mA</p> <p>1 = 4-20 mA</p>
A.7	<p>Resolution. Specifies whether output should be in high resolution if the display is showing high resolution.</p>	<p>0 = Display</p> <p>1 = Internal</p>
A.8	<p>Operation. Enables and disables the analog output.</p>	<p>0 = Disabled</p> <p>1 = Enabled</p>

4 Calibration

Before you can calibrate the scale, you must ensure that jumper JP1 is not in the sealed position (see section 4.4). There are two ways to calibrate the VT200/220:

- Standard weights calibration, in which you record the center of zero, and then place a known weight on the scale and enter its weight (see section 4.1).
- Electronic calibration, in which you enter the mV value of the minimum and maximum weight (see section 4.2).

Both of the above are performed using the **CAL** setup menu.

After calibrating the scale, you must store calibration data in persistent memory (see section 4.3), and seal the calibration lock (see section 4.4).



If you have two scales connected to the indicator, each scale has its own calibration parameters. All the parameters in the **CAL** menu relate to the currently active scale. To calibrate scale 2, for instance, switch to scale 2 by pressing **SCALE** ()**2**), and then access the **CAL** menu and perform calibration.

4.1 Calibration with Standard Weights (S-CAL)

Calibration with standard weights is done in two stages:

- Zero calibration, in which you take a weight measurement when there is nothing on the scale (see section 4.1.1). This is also called dead-load adjustment.
- Span calibration, in which you place a known weight on the scale, and manually enter its correct weight (see section 4.1.2).





You must perform both of the above for the scale to be calibrated properly.





After calibrating the scale, you must save the values in permanent memories by entering the setup menus and selecting the **STORE** option (see section 4.3). It is also advised to lock calibration (see section 4.4).

4.1.1 Zero (Dead-Load) Calibration











➔ **To perform zero calibration:**

1. Enter the setup menus and use **TOTAL** () to scroll to the **CAL** menu. Press **PRINT** () to enter the menu.
2. Press **PRINT** () to enter the **S-CAL** menu.
3. Press **PRINT** () to select the **ZERo** option (zero calibration).
4. The display shows **E Sc1**. Clear the scale, and wait about 10 seconds.

5. Press **PRINT** () to record the zero position. The display counts down for about 10 seconds (50 measurements are taken and an average is calculated).
6. The display should now show 0. If the zero point is not accurate, press **ZERO** () and go back to step 3.

4.1.2 Span Calibration

➔ To perform span calibration:

1. Enter the setup menus and use **TOTAL** () to scroll to the **CAL** menu. Press **PRINT** () to enter the menu.
2. Press **PRINT** () to enter the **S-CAL** menu.
3. Use **TOTAL** () to scroll to the **SPAN** option, and press **PRINT** () to select it.
4. The display shows the maximum capacity of the scale. Enter the correct calibration weight, using **P.TARE** () to edit the current digit and **TARE** () to move to the next digit.
5. Press **PRINT** () to confirm the calibration weight.
6. The display shows **Add Ld.** Place the calibration weight on the scale, and wait about 10 seconds.
7. Press **PRINT** (). The display counts down for about 10 seconds, and then shows the calibration weight.
8. If the weight shown is not accurate, press **ZERO** () and go back to step 4.

4.2 Electronic Calibration (E-CAL)

Electronic calibration involves setting two values, using the indicator keypad:

- The signal level in mV, corresponding to the zero, or dead-load point (see section 4.2.2).
- The signal level in mV, corresponding to the maximum capacity of the scale (see section 4.2.3).

To learn how to calculate these values from the load cell specifications provided by the manufacturer, see section 4.2.1 below. You must perform both of the above for the scale to be calibrated properly.



After calibrating the scale, you must save the values in permanent memories by entering the setup menus and selecting the **STORE** option (see section 4.3). It is also advised to lock calibration (see section 4.4).

Calibration

Electronic Calibration (E-CAL)

4.2.1 Calculating Calibration Values

Consider the following example. A scale has maximum capacity 30/60kg, $e=0.010/0.020\text{kg}$, with 4 load cells of rated capacity 50kg - 2mV each and dead load 1.940kg. The load cell data, as noted in the manufacturer data sheet, is shown in the following table.







Load cell	Output at 50kg	Zero balance
L/C1	1.9793mV	0.0257mV
L/C2	1.9392mV	0.0276mV
L/C3	1.9577mV	0.0553mV
L/C4	1.9640mV	-0.0022mV

➔ **To calculate the dead-load and span calibration values:**

1. Calculate an average of the load cells' rated output. In the example above, this equals $(1.9793+1.9392+1.9577+1.9640)/4 = 1.9600\text{mV}$.
2. Calculate the combined output of the load cells when the scale is at maximum capacity. In the example above, this equals $1.9600 \times 60 / 4 \times 50 = \mathbf{0.5880\text{mV}}$. This is the *span calibration value*.
3. Calculate an average of the load cells' zero balance. In the example above, this equals $[0.0257+0.0276+0.0553+(-0.0022)]/4=0.0266\text{mV}$.
4. Calculate the scale dead-load. In the example above, this equals $1.9600 \text{ mV} \times [1.940\text{Kg} / (4 \times 50\text{Kg})] = 0.0190\text{mV}$.
5. Calculate the overall dead-load by adding together the load cell zero balance and the scale dead-load (calculated in step 4). In the example above, this equals $0.0266+0.0190 = \mathbf{0.0456\text{mV}}$. This is the *dead-load calibration value*.









4.2.2 Setting Zero Calibration (Dead-Load) Value

➔ **To set the zero calibration value electronically:**

1. Enter the setup menus and use **TOTAL** () to scroll to the **CAL** menu. Press **PRINT** () to enter the menu.
2. Press **PRINT** () to enter the **E-CAL** menu.
3. Press **PRINT** () to select the **ZERo** option (zero calibration).
4. Enter the overall mV of the dead-load (see chapter 4.2.1 to learn how to calculate it). Use **P.TARE** () to edit the current digit and **TARE** () to move to the next digit.
5. Press **PRINT** () to record the zero calibration value. The display shows the corresponding weight.

4.2.3 Span (Max. Capacity) Calibration



➔ To set the span calibration value electronically:

1. Enter the setup menus and use **TOTAL** () to scroll to the **CAL** menu. Press **PRINT** () to enter the menu.
2. Press **PRINT** () to enter the **E-CAL** menu.
3. Use **TOTAL** () to scroll to the **SPAN** option, and press **PRINT** () to select it.
4. Enter the overall mV of the scale's maximum capacity (see chapter 4.2.1 to learn how to calculate it). Use **P.TARE** () to edit the current digit and **TARE** () to move to the next digit.
5. Press **PRINT** () to confirm the maximum capacity calibration value. The display shows the corresponding weight.

4.3 Storing Calibration Data

After calibrating the scale (using either method) or the analog output, calibration data is stored in volatile memory only, and so it is lost when the indicator powers down. To store the calibration data permanently, follow the procedure below.

➔ To perform span calibration:

1. Enter the setup menus and use **TOTAL** () to scroll to the **STORE** option.
2. Press **PRINT** (). The indicator exits the setup menus and re-initializes.

4.4 Locking and Unlocking Calibration

An internal jumper (JP1, located on the main printed circuit board next to the analog circuit) must be removed to allow access to configuration and calibration parameters. One way to seal the indicator is to prevent access to this jumper. This is done by placing a brittle plastic sticker over one of the screws that keeps the cabinet closed.

The indicator also has an *Audit Trail Counter*, which is incremented every time weight parameters or calibration are changed, regardless of whether the change was saved in EEPROM or not. This counter allows the authorities to check if any calibration attempt has been made since the last inspection.



A label with an inscribed count (all digits permanently printed and suffixed by a hyphen) is placed on the rear side of the instrument. The label is designated CAL-Nr and may not be removed without destroying it.



Seals bear the verification mark of a notified body or alternative mark of the manufacturer according to Annex II, section 2.3 of the Directive 90/384/EEC.

4.4.1 Sealing Indicator Enclosure with Stickers

After calibration, you can seal the indicator with two stickers:

- A non-removable label, to prevent unauthorized opening of the indicator enclosure (Figure 7).
- A lead wire seal or hard plastic sticker, to prevent unauthorized tampering with the load cell connector (Figure 8).



Figure 7 – Non-removable sticker



Figure 8 – Lead wire seal / hard plastic sticker

➔ To seal the indicator, wall-mount (stainless steel) model:

Refer to Figure 9 below.

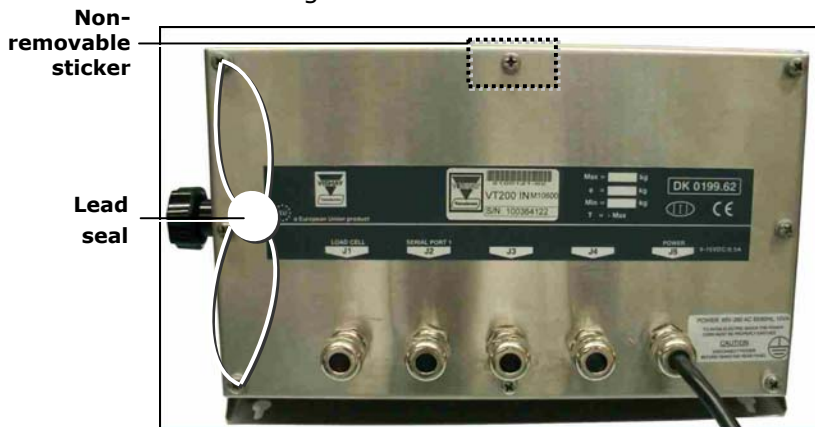

Figure 9 - Wall mount model, sealing instructions

➔ To seal the indicator, desktop (aluminum) model:

For the desktop (aluminum) model, refer to Figure 10 below for the non-removable sticker, and to Figure 11 for the lead seal / non-removable sticker. You must apply both stickers.

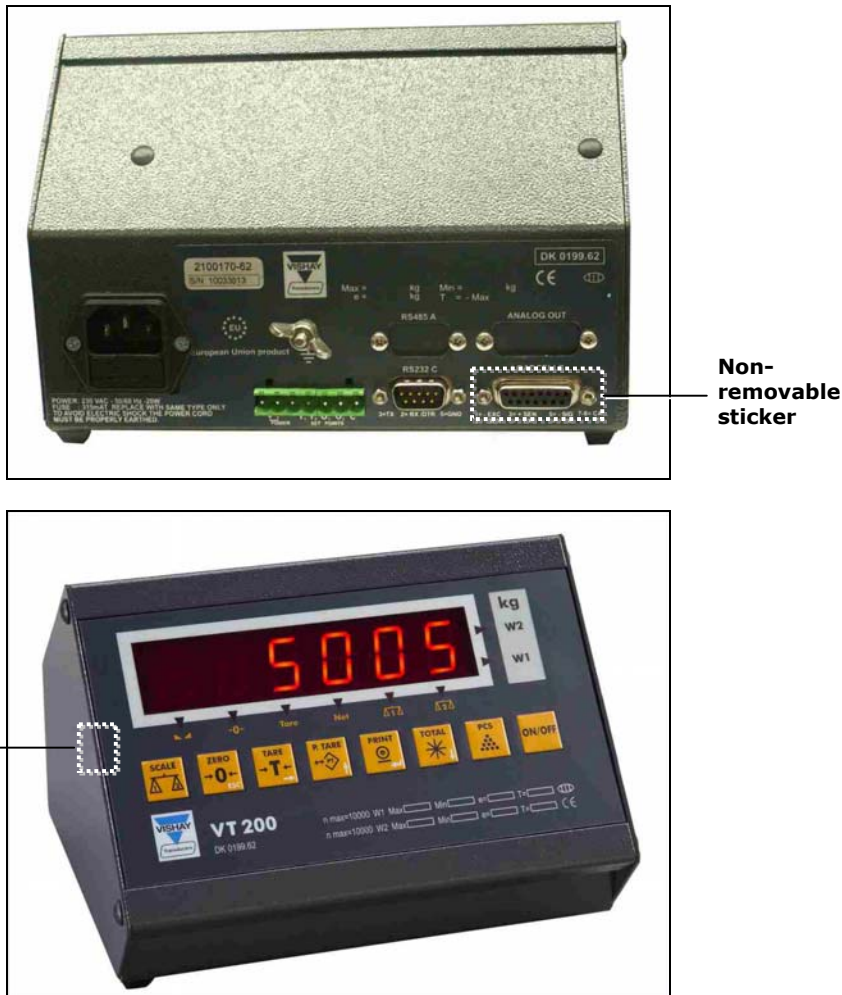

Figure 10 – Desktop model, sealing with non-removable sticker

Calibration

Locking and Unlocking Calibration



Figure 11 – Desktop model, sealing with lead seal / non-removable sticker

4.4.2 Securing Load Receptor

You can inscribe the serial number of the load receptor as part of the indicator identification label.



The load receptor bears the serial number of the indicator on its data plate.

4.4.3 Checking Seal Status and Audit Trail Counter

In order to check whether the jumper is still in the sealed position, and that the audit trail counter has not changed.

➔ **To check seal status and audit trail counter:**

Execute function 48. If JP1 is currently in the sealed position, the word `SEALED` appears on the display briefly. Following this, the audit trail counter is displayed.

5 General System Parameters

Two of the VT200/220 setup menus provide access to general system parameters, which affect how the scale operates:

- The **PAR** menu contains parameters including the number of display digits, the position of the decimal point, the A/D gain and the zero range (see chapter 5.1).
- The **SETUP 1** submenu, inside the **SETUP** menu, contains parameters including the date format, totalizer enabling and auto power off (see chapter 5.2).







If you have two scales connected to the indicator, each scale has its own set of parameters. All the parameters in the menus relate to the currently active scale. To change parameters for scale 2, for instance, switch to scale 2 by pressing **SCALE** ()^{SCALE}, and then access the menu and change the required parameters.

Other setup menus allow you to calibrate the scale (**CAL** menu; see chapter 4); set communication parameters (**SETUP 2** and **SETUP 3**; see chapter 6); and input/output parameters (**SETUP 4**, **SETUP 5** and **ACAL**; see chapter 7).





5.1 PAR Menu

5.1.1 Accessing the Menu and Editing Parameters

➔ **To access the PAR menu:**

1. Turn on the unit.
2. During the self-test routine, while all display segments are on (all 8 on the display), press **PRINT** ()^{PRINT} momentarily, followed by **TARE** ()^{TARE} momentarily.
3. If the PIN code is activated, the display shows **ACCESS** briefly. Type the PIN and press **PRINT** ()^{PRINT} to enter the calibration menu. The display shows **SETUP**.
4. Use **TOTAL** ()^{TOTAL} to scroll to the **PAR** menu.
5. Press **PRINT** ()^{PRINT} to enter the menu.

➔ **To edit parameters in the PAR menu:**

1. The current parameter number is shown on the display. Use **PRINT** ()^{PRINT} to scroll to the parameter you need (see the following section for descriptions of parameters).
2. To edit the parameter value, use **P.TARE** ()^{P.TARE} to increment the current digit and **TARE** ()^{TARE} to move to the next digit (if any).
3. When the display is showing the required value, press **PRINT** ()^{PRINT} to confirm your selection.

General System Parameters

PAR Menu





5.1.2 PAR Menu Parameters

Par.	Description	Values
1.P	Number of display digits.	4, 5, 6
2.P	Number of digits after decimal point. Defines the position of the decimal point*.	0-5
3.P	Display resolution*.	1-200
4.P	First two digits of full load.	00-99
5.P	Digital filter. If set to X, filter averages 2 ^x samples.	0-5
6.P	Number of conversions per second. If there are two scales connected, the sum of their conversion rates (6P+6P) must be less than 70. Otherwise the unit sets 6.P=14 for each scale.	3, 7, 14, 28, 57, 70
7.P	No-motion samples. If set to X, samples = 2 ^x .	1-7
8.1	Zero Tracking. In Display resolution (3.P) units / 1 second.	0F=disabled 0.5, 1, 2, 3, 5, 9.
8.2	Auto-zero at power up.	0=NO 1=YES
8.3	Dual digital filter (Antiflicker).	0=NO 1=YES
8.4	Automatically clear A/D converter error (Error 05). NO specifies that, when the A/D converter is enabled, errors are automatically cleared when the cause is no longer present. YES specifies that A/D converter errors should remain on the display until the operator presses PRINT .	0=NO 1=YES
8.5	Flash low battery indicator.	0=NO 1=YES
8.6	Leading zero blank.	0=NO 1=YES
8.7	Load cell amplifier gain adjustment (A/D Gain) 2mV/V setting allows maximum utilization of 1.75mV/V. 4mV/V setting allows maximum utilization of 3.75mV/V.	0=2mV/V (1.75mV/V utilization) 1=4mV/V (3.75mV/V utilization)
8.8	AC/DC excitation. AC sets load cell excitation to AC, and specifies that polarity excitation should be switched at the conversion rate. Switching excitation results in a more stable zero. DC sets load cell excitation to DC.	0=AC 1=DC
8.9	Second scale connected (second analog input). Enables/disables the SCALE button.	0=NO 1=YES
8.A	Zero range. Some operations, including taring and printing, are only active within the zero range.	0=2% 1=10%
8.b	Dual interval or range. This parameter is not relevant if 0.P=00.	0=interval 1=range
8.c	Unit select. Specifies if weights are measured in kilograms or pounds.	0=Kg 1=Lb
0.P	First two digits of weighing range, defining the limit between the 2 weighing ranges, the lower display division is automatically selected. If set to 00, disables interval / range.	00 - 99

* Refer to Section 5.1.3 for how to set parameters when using two scales.

5.1.3 Dual-scale Connecting And Parameter Settings

➔ To connect and set up VT200 for dual-scale operations:

1. Set **PAR** parameters **8.9** to 1, **0.P** to 00, and **6.P** to a value less than 70 (see 5.1).
4. Ascertain that the Scale1 is calibrated and working properly ( lit).
5. Power down the unit. Connect the second scale to **ST5** - 7 pins socket in the one side and in the other side:
Stainless Steel Enclosure – To the main board using the mounting posts/spacers provided.
Aluminum Enclosure – To the indicator's rear panel (see page 80) using the mounting posts/spacers provided.
 Power up the unit.
6. Ascertain that the Scale2 values for parameters **2.P** and **3.P** are the same as those for Scale1 (see 5.1).
7. After checking that the  annunciator is lit (switching with the **SCALE** key), calibrate the second scale.
8. The device is now ready to work in dual-scale mode.
7. Use the **SCALE** key for switching between Scale1, Scale2 or sum of Scale1+Scale2 ( and  annunciators lit).









Second scale is not supporting Continuous weight output-AND protocol see 6.3.2

5.2 SETUP 1 (Inside SETUP Menu)

5.2.1 Accessing the Menu and Editing Parameters





➔ To access the **SETUP 1** menu:

1. Turn on the unit.
2. During the self-test routine, while all display segments are on (all 8 on the display), press **PRINT** () momentarily, followed by **TARE** () momentarily.
3. If the PIN code is activated, the display shows **ACCESS** briefly. Type the PIN number and then **PRINT** () to get into the calibration menu. The display shows **SETUP**.
4. Use **TOTAL** () to scroll to the **SETUP** menu and press **PRINT** () to enter it.
5. Press **PRINT** () to enter the **SETUP 1** menu.

General System Parameters

SETUP 1 (Inside SETUP Menu)

➔ To edit parameters in the SETUP 1 menu:

1. The current parameter number is shown on the display. Use **PRINT** () to scroll to the parameter you need (see the following section for descriptions of parameters).
2. To edit the parameter value, use **P.TARE** () to increment the current digit and **TARE** () to move to the next digit.
3. When the display is showing the required value, press **PRINT** () to confirm your selection.

5.2.2 SETUP 1 Parameters



Parameters 1.2, 1.3, 1.5 and 1.7 are not in use in this version of the VT200/220, and so are not detailed in the table below.

Par.	Description	Values
1.1	Enable totalizer. YES enables the totalizer. NO disables it.	0=NO 1=YES
1.4	Date format. Sets the date format in all printing formats.	0=d-m-y 1=m-d-y
1.6	Enable battery-backed RAM. If the battery-backed RAM option is installed, this parameter enables saving date, time and the accumulated total in persistent memory. You must enable this parameter to be able to set date and time.	0=NO 1=YES
1.8	Enable function menu. YES specifies that users can access the function menu by pressing TARE for 3 seconds. NO specifies that users should not be able to access the function menu.	0=NO 1=YES
1.t	Auto power off. Time for the unit to switch off if the scale is zero.	00-99 minutes 00=Disabled
1.E	Number of samples in counting.	5-99

6 Serial Communication

Communication and printer parameters can be set in the **SETUP 2** and **SETUP 3** submenus of the **SETUP** menu.

6.1 Serial Ports Configuration

VT200/220 has two serial ports, designated port 1 and port 2:

- Port 1 is an RS232 port.
- Port 2 is an optional port installed on order, and can be either RS232 or RS485.

6.1.1 RS232 Serial Port

The port is used to connect to serial printers or personal computers.

General	Asynchronous serial ASCII, RS232C standard, full duplex.
Protocol	1200, 2400, 4800 or 9600 baud rate, 1 start bit, 8 data bits/no parity or 7 data bits/odd or even parity, 1 stop bit.
Handshake	DTR BUSY per character for fanfold printers or REQUEST PAPER END STATUS for EPSON TM-295 slip printer.
Connection	Cable gland, stainless steel enclosure or DB9 male on rear panel, aluminum enclosure (J1 or J3). Three-conductor shielded cable, max distance 15m. Tx = Pin 3 Rx/DTR = Pin 2 GND = Pin 5

6.1.2 RS485 Serial Port

Used to connect to a host computer, remote printer, remote display, etc.

General	Asynchronous serial ASCII, RS485 half duplex.
Protocol	2400 to 57600 baud, 1 start bit, 8 data bits/even or no parity 7 data bits/even parity, 1 stop bit.
Connection	Cable gland, stainless steel enclosure or DB9 female on rear panel aluminum enclosure (J3). Two-conductor twisted-pair shielded cable, max distance 1000m. A termination resistor (120R) may be connected by shorting pins 8 and 9. A = Pin 6 B = Pin 7

6.2 Setting Port Output Parameters

6.2.1 Setting Port 1 Output

You can use setup parameter **2.t** to determine the output for port 1. The parameter accepts the following values:

- 00 – port disabled.
- 01, 03, 04, 05, 06, 07, 08, 10, 20 – print formats for printer, equivalent to functions 21, 23, 24, 25, 26, 28, 30, respectively. See section 3.3.2.
- 02 – continuous weight output. See section 6.3.2.
- 09 – print on demand. See section 6.3.3.
- 13 – transmit alibi memory. See section 6.3.4.

6.2.2 Setting Port 2 Output

You can use setup parameter **3.t** to determine the output for port 2. The parameter accepts the following values:

- 00 – port disabled.
- 01 – continuous weight output. See chapter 6.3.2.
- 02 – EDP protocol output. See chapter 6.3.5.
- 03 – printing data from local printer on remote printer. See chapter 6.3.6.
- 65 through 89 – participate in a network of several indicators as slave, with this address.

6.3 Output Types

6.3.1 Local Printer

Works with port 1. A slip is printed on the printer connected to the port each time the user presses **PRINT** (). The following print formats are available:

- Ten standard print formats (see section 6.4).
- Two custom print formats (see section 6.5).

6.3.2 Continuous Weight Output

Works with ports 1 and 2 (RS232 or RS485). Net weight and status information is transmitted continuously. No handshake is required. Used mainly for remote display or PC. The structure of the transmitted data block is shown below. There are 2 Continuous Weight Output selectable (parameters **2.2** and **3.6**) formats LEO and AND (AND protocol is supported only by Scale 1).

Continuous Weight Data Block Composition LEO Format

Byte	Name	Description
1	Weight status	Bit 0: 0=Normal 1=No weight display Bit 1: 0=Gross 1=Net Bit 2: 0=No Auto zero 1=Auto zero Bit 3: 0=Within range 1=Out of range Bit 4: 0=No standstill 1=Standstill Bit 5: 0=Normal 1=Under minimum weighing range Bit 6: Must be always set to 1 Bit 7: Zero or parity
2	Polarity	"+" or "-".
3-8	Net weight	6 digits, including decimal point if any.
9	Sync	Carriage return (0D hex) for end of transmission.

Continuous Weight Data Block Composition AND Format

Byte	Name	Description
1-2	Weight status1	ST - Weight is stable US - Weight is unstable OL - Weight is overloaded
3		Always ",", (Comma 2C hex)
4-5	Weight status2	GS - Weight is gross NT - Weight is net TR - If regular tare is in system, when pressing P.TARE key, TR will be displayed briefly. PT - If preset tare is in system, when pressing P.TARE key, PT will be displayed briefly.
6		Always ",", (Comma 2C hex)
7	Polarity	"+" or "-"
8-14	Weight	7 digits, including decimal point (2E hex) if any
15-16	Weight Unit	"kg" for kilogram, space (20 hex) +"t" for ton and "lb" for pound.
17-18	Sync	CR+LF - Carriage return (0D hex) and Line feed (0A hex) for end of transmission.

Two-Scale Operation

When two scales are connected to the indicator, both their weights are transmitted continuously in the format $P+123.45 P+678.90CR$. In each pair, the first block transmitted is the weight of the first scale, and the second block transmitted is the weight of the second scale.

For this mode of operation, the parameter settings are **SETUP > SETUP 2: 2.t=22**, and **SETUP > SETUP 3: 3.t=11**.

The format of the data block, for each scale, is shown below.

Byte	Name	Description
1	Weight status	Bit 0: 0=Normal 1=No weight display Bit 1: 0=Gross 1=Net Bit 2: 0=No Auto zero 1=Auto zero Bit 3: 0=Within range 1=Out of range Bit 4: 0=No standstill 1=Standstill Bit 5: 0=Normal 1=Under minimum weighing range Bit 6: Always 1 Bit 7: Zero or parity
2	Polarity	"+" or "-".
3-8	Indicated weight	6 digits, including decimal point if any.
9	Sync	Carriage return (0D hex) for end of transmission.

6.3.3 Continuous Weight With Tare

Works with port 2 (RS232 or RS485).

This option can be programmed by setting setup parameter **3.t** to 06. The weight indication of each scale is transmitted continuously along with its current tare and gross weight. The format is:

$P+123.45N010.00(T/P)133.45G$

Where the characters indicate:

- N for Net weight.
- G for Gross weight.
- T for the Tare weight when the scale was manually tared, or P for the tare weight when the tare was preset either from the device or from a PC.

Data Block Composition

Byte	Name	Description
1	Weight status	Bit 0: 0=Normal 1=No weight display Bit 1: 0=Gross 1=Net Bit 2: 0=No Auto zero 1=Auto zero Bit 3: 0=Within range 1=Out of range Bit 4: 0=No standstill 1=Standstill Bit 5: 0=Normal 1=Under minimum weighing range Bit 6: Must be always set to 1 Bit 7: Zero or parity
2	Polarity	"+" or "-".
3-8	Net weight	6 digits, including decimal point if any.
9	"N"	Indicates that the preceding weight is net.
10-15	Net weight	6 digits, including decimal point if any.
16	"T" or "P"	"T" specifies that the preceding weight is a manual tare. "P" specifies that the preceding weight is a preset tare.
17-22	Gross weight	6 digits, including decimal point if any.
23	"G"	Indicates that the preceding weight is gross.
24	Sync	Carriage return (0D hex) for end of transmission.

When Display Indication is Not Weight

When the indicator displays something other than weight, the data string to COM2 will be as follows:

```
|A|XXXX|TARE VALUE|T/P|GROSS VALUE|G|CR
```

"XXXX" in the format above will either be blank spaces, an error message, or the menu currently accessed by the user.

6.3.4 Print on Demand

Works with Port 1 (RS232). Weight data is transmitted every time a character is received from a connected peripheral. The demand character is programmed in setup **3.t**: for example "1", 49d, or 31 hex.

6.3.5 Alibi Transmit

Works with Port1 (RS232).

Transmits alibi serial number and gross weight for each transaction, when the **PRINT** key is pressed. The record is transmitted in the following format:

```
SN 1234 012340 kgG
```

6.3.6 Alibi Mode Commands

When Alibi mode is active (**2.t=09**), these operations can be executed.

Transmit Displayed Weight

This is executed when ASCII character ? (3F hex) is received. The output data block is as shown below:

Byte	Name	Description
1	Weight status	Bit 0: 0=Normal 1=No weight display
		Bit 1: 0=Gross 1=Net
		Bit 2: 0=No Auto zero 1=Auto zero
		Bit 3: 0=Within range 1=Out of range
		Bit 4: 0=No standstill 1=Standstill
		Bit 5: 0=Normal 1=Under minimum weighing range
		Bit 6: Must be always set to 1
	Bit 7: Zero or parity	
2	Polarity	"+" or "-"
3-8	Weight	6 digits, including decimal point if any
9	Sync	Carriage return (0D hex) for end of transmission.

Command "ZERO"

Equivalent to pressing the front panel Zero key. This is executed when ASCII character 0 (30 hex) is received. No data is returned to the host. Execution of the command may be verified by examining the weight (command ?).

Print on Demand Character

When a demand character is received the unit saves the weight in its Alibi flash. It then transmits the Alibi number and the weight, for example: 1234 012.340 kg

The demand character may be programmed through **SETUP > SETUP 2**, setting **2.c=65-90 (A-Z)**. **A** (41h) will generate and transmit the new Alibi number; **a** (61h) will repeat the last Alibi number (in the case where the message was not received properly).

6.3.7 EDP Protocol Output

Works With Port 2 (RS232 or RS485).

Transmits weight measurements to a host computer, according to the currently-selected print format, with or without an ENQ prompt, and with or without an ACK/NAK handshake (see Relevant Setup Parameters below).

The EDP protocol works when more than one indicator is connected to the host PC. It is also more flexible than Print on Demand, allowing for more complex operations. It can also transmit more than just the weight measurement shown on the display, because it sends data according to the currently-selected print format.

Full Protocol Workflow

1. Within 5 seconds of initialization, the PC requests data by sending an ENQ (05 h) command. If it doesn't send an ENQ, the indicator shows Error 30 (host not ready).
2. After the **PRINT** () button is pressed, the indicator transmits weight information according to the currently-selected print format, using the standard data block composition (shown below).
3. Within 5 seconds of transmission, the PC either:
 - Acknowledges receiving the data properly, by sending an ACK (06 h) command.
 - Notifies the indicator the data was not properly received, by sending a NAK (15 h) command.
 - Does not respond, in which case the indicator shows error 33 (host does not acknowledge).
4. If the host responded with a NAK command, steps 2 and 3 are repeated. The number of repeats is unlimited.

Relevant Setup Parameters

- **3.1** – timeout control. 0=No; 1=Yes. Turning off timeout removes the 5-second constraint in workflow steps 2 and 4. Errors 30 or 33 are never shown.
- **3.2** – handshake. 0=No; 1=Yes. Turning off handshake removes steps 4 and 5 of the protocol workflow - the indicator sends data blocks on demand, without waiting for a response.
- **3.3** – operator disable. 0=No; 1=Yes. If set to 1, any key pressed on this indicator interrupts EDP communications.
- **3.4** – host enquiry. 0=No; 1=Yes. Turning off host enquiry specifies that the indicator should send weight information continuously, not on demand.

EDP Data Block Composition

Character/s	Description
STX (02 h)	Start of transmission.
ASCII (any)	ASCII data identical to the data printed.
ETX (03 h)	End of transmission.
BCC	Block check character (XORSUM of all data characters STX, ETX inclusive).

6.3.8 Remote Printer Output

Works with Port 2 (RS232 or RS485). Used to transmit the data printed on the local printer to a remote printer. No handshake is required.

6.3.9 Master-Slave Protocol Output

Works with Port 2 (RS232 or RS485). By setting port 2 output method (parameter **3.t**) to any number between 65 and 89, you specify that the indicator should participate in a network of several indicators. The number set in **3.t** is this indicator's network address.

Master-Slave Commands

Port 2 (RS232, RS485)

List of File Types (Commands)

Command	Hex	Description	Time	Slave Response
?	3F	UPLOAD WEIGHT & STATUS	50 ms	STATUS + WEIGHT
@	40	RESET SLAVE	15ms	NONE
K	4B	DOWNLOAD KEY	0.1 ms	NONE

? Upload Status

It is the main command used to poll the SLAVE(s), which reply with the current weight being measured or with a message if bit 0 of the status byte is '1'. In the normal state the SLAVE will respond within 3-4 character time.

(e.g. with 9600 baud, character time \approx 1 msec, the master should expect reception of STX from the SLAVE within 5 msec after the ETX was transmitted from the master).

Master Transmission

STX	ADD	?	0	BCS2	BCS1	ETX
-----	-----	---	---	------	------	-----

Example:

	STX	ADD	?	0	BCS2	BCS1	ETX
Hex	2	41	3F	30	3C	34	3
Ascii	STX	A	?	0	<	4	ETX

- ADD (Address) is set in **3.t** = 65-90 (A-Z)
- CheckSum is calculated as the XOR sum of all data characters, ETX excluded.
E.g. 02 XOR 41 XOR 3F XOR 30 = 4C (BCS1 = 30+C=3C, BCS2 = 30+4=34)

Slave Response

STX	ADD	?	0	STATUS BYTE	WEIGHT	X	Y	Z	BCS2	BCS1	ETX
-----	-----	---	---	-------------	--------	---	---	---	------	------	-----

WEIGHT = 5 digits + decimal point if any. (ASCII,MSD FIRST)

X = Scale number

- 0 = Scale 1 + Scale 2
- 1 = Scale 1
- 2 = Scale 2

Y = Digital input (TILT)

- 0 = Not Active
- 1 = Active

Z = Setpoints

- 0 = Neither is active
- 1 = Setpoint 1 is active
- 2 = Setpoint 2 is active
- 3 = Setpoint 1, Setpoint 2 are active

Status Byte

B7	B6	B5	B4	B3	B2	B1	B0
Zero or Parity	1	Under Min. Weighing Range 0=NO, 1=YES	No Motion 0=NO, 1=YES	Out of Range 0=NO, 1=YES	Autozero 0=NO, 1=YES	0=Gross 1=Net	0=Normal Weight 1=No Weight

The slave response will contain a message in place of the weight if b0 of the status byte is high.

Serial Communication

Output Types

@ Reset Slave

Resets the slave to its power on condition.

Master Transmission

STX	ADD	@	0	BCS2	BCS1	ETX
-----	-----	---	---	------	------	-----

Slave Response

None.

Download Key

This is used to download keyboard commands. Use of remote keyboard commands must be enabled: This is done by the setting **SETUP3: 3.5=ON**.

Master Transmission

STX	ADD	K	0	xx	BCS2	BCS1	ETX
-----	-----	---	---	----	------	------	-----

XX values (2 bytes):

- 30 = Keyscale1 2
- 31 = Keyesc
- 32 = Keyright
- 33 = Keyup
- 34 = Keyenter
- 35 = Keydown
- 36 = Keyfn
- 37 = Keypieces
- 38 = Keybattery
- 39 = Keyfnpieces

Slave Response

None.

Gross-Tare-Net Weight Transmission

The output data format of the master-slave protocol is shown below:

STX	ADD	=	0	XXXXXX	BCS2	BCS1	ETX
-----	-----	---	---	--------	------	------	-----

The output data block is as shown below:

Byte	Name	Description
1	Weight status	Bit 0: 0=Normal 1=No weight display Bit 1: 0=Gross 1=Net Bit 2: 0=No Auto zero 1=Auto zero Bit 3: 0=Within range 1=Out of range Bit 4: 0=No standstill 1=Standstill Bit 5: 0=Normal 1=Under minimum weighing range Bit 6: Must be always set to 1 Bit 7: Zero or parity
2	Polarity	"+" or "-"
3-8	Net weight	6 digits, including decimal point if any
9	"N"	Indicates that the preceding weight is net.
10-15	Net weight	6 digits, including decimal point if any
16	"T" or "P"	"T" specifies that the preceding weight is a manual tare. "P" specifies that the preceding weight is a preset tare.
17-22	Gross weight	6 digits, including decimal point if any
23	"G"	Indicates that the preceding weight is gross.
24	Scale number	Either 1 or 2

Tare Presetting via PC

The command for taring the device is 'T0' and it has the following format:

STX	ADD	T	0	XXXXXX	BCS2	BCS1	ETX
-----	-----	---	---	--------	------	------	-----

XXXXXX, the tare weight, is the 6 digit required tare. For example (assuming no decimal point), 000010=10kg tare; 000100=100kg tare.

If the scale is set to accuracy of 1 decimal point then 000010=1kg tare;
000100=10kg tare.

Separation of COM1 and COM2 Network Addresses

You can program a separate address for COM1, mainly for Alibi purposes but also for other possible future uses. This is done by setting setup parameter **2.C**=65-90 (that is A to Z) according to your requirements.

6.4 Standard Print Formats

You can select one of the ten VT200/220's standard print formats, shown and explained in the table below, using the function menu (functions 21 through 30). Executing the function that corresponds to a print format makes it the current print format. This is the format used by the printer when users press **PRINT** ()



It is also possible to download one of two custom print formats (see section 6.5).

Func.	Name of Print Format	Contents (in this order)	Layout
21	Ticket	Date, time, weight. Whether a gross or net weight is shown depends on the current VT200/220 mode.	<div style="border: 1px solid black; padding: 5px;"> <p>29-04-03 09:15 N:0010</p> <p>WEIGHT : <123.40 kg></p> </div>
22	Continuous output	Sends the current weight measurement and status to an external device (a display or PC). Layout depends on the settings of the external device. There are 2 Continuous output formats LEA and AND see 6.3.2	
23	Net/gross	Either net or gross weight, depending what is shown on the display.	<div style="border: 1px solid black; padding: 5px;"> <p>GROSS : <05210kg></p> </div> <p>OR</p> <div style="border: 1px solid black; padding: 5px;"> <p>NET : <00950 kg></p> </div>
24	3-line detailed weight	When net weight is showing: Gross weight, tare value and net weight. When gross weight is showing: Gross only.	<div style="border: 1px solid black; padding: 5px;"> <p>GROSS : 07940kg</p> <p>TARE : 06170kg</p> <p>NET : 01770kg</p> </div> <p>OR</p> <div style="border: 1px solid black; padding: 5px;"> <p>GROSS : <06170kg></p> </div>
25	3-line detailed weight large	Gross weight, tare value and net weight in large characters.	<div style="border: 1px solid black; padding: 5px;"> <p>GROSS : 07940kg</p> <p>TARE : 06170kg</p> <p>NET : 01770kg</p> </div>

Func.	Name of Print Format	Contents (in this order)	Layout						
26	1-line detailed weight	When net weight is showing: Memory serial number, gross weight, tare value and net weight. When gross weight is showing: Memory serial number and gross weight.	<div style="border: 1px solid black; padding: 2px; display: inline-block;">1234 09260kgG 07940kgT 01320kgN</div> OR <div style="border: 1px solid black; padding: 2px; display: inline-block;">1234 07940kgG</div>						
27	Displayed weight	The number currently showing on the display.	<div style="border: 1px solid black; padding: 2px; display: inline-block;">00439.5</div>						
28	Displayed weight and serial	Memory serial number and weight shown on the indicator screen	<div style="border: 1px solid black; padding: 2px; display: inline-block;">1234 00439.5kg</div>						
29	Demand	Gross weight is sent to an external device on request (when an ENQ is received).	<div style="border: 1px solid black; padding: 2px; display: inline-block;">GROSS:<00.500kg></div>						
30	2-line label	Gross weight, tare value and net weight.	<table border="1" style="border-collapse: collapse; width: 100%;"> <thead> <tr> <th style="padding: 2px;">GROSS</th> <th style="padding: 2px;">TARE</th> <th style="padding: 2px;">NET</th> </tr> </thead> <tbody> <tr> <td style="padding: 2px;">12.345</td> <td style="padding: 2px;">02.345</td> <td style="padding: 2px;">10.000</td> </tr> </tbody> </table>	GROSS	TARE	NET	12.345	02.345	10.000
GROSS	TARE	NET							
12.345	02.345	10.000							

6.5 Custom Print Formats

In addition to the standard print formats, there are two custom print formats, activated by function 41 for gross mode and function 42 for net mode.

6.5.1 Creating a Custom Print Format

A custom print format is created on a PC, as an ASCII file that may be no larger than 511 bytes. The ASCII file can have two types of text:

- Fields – text with the format [!xx], where xx is the field code. When a ticket is printed, each field added to the print format is added with data from the current weight measurement. The table below lists all the field codes.
- Fixed text – any ASCII characters that do not specify a field. These characters are printed regardless of the data in the current weight measurement.

When you follow the procedure for downloading a custom print format (see section 6.5.2 below), the indicator uploads the default print format to the PC, as an ASCII file. You can edit this file to create the custom print format.

Field Codes Allowed in Custom Print Formats

- [!005] – date (when RTC option is installed).
- [!011] – average piece weight used in counting
- [!012] – number of pieces counted.
- [!013] – time (when RTC option is installed).
- [!014] – gross weight.
- [!015] – current tare value.
- [!016] – current memory serial number.
- [!017] – net weight.
- [!042] – current accumulated total.
- [!098] – unit of weight.

Example of Custom Print Format

```
Vishay Transducers  
WEIGHT <[!014] kg>  
N: [!016]
```

The above code results in the following printed ticket:

```
Vishay Transducers  
WEIGHT <12345 kg>  
N: 0001
```



6.5.2 Downloading a Custom Print Format

Before you can download a custom print format, you must create it on a PC, as an ASCII file 511 bytes or less in length (see the previous section).

The VT200/220 can store up to two custom print formats, in two memory slots. Function 41 is used to download a print format to the first slot; function 42 is used to download a print format to the second slot. You can download a custom print format to one or both slots.



➔ To download a custom print format:

1. Connect a PC to port 1 on the indicator, set baud rate = 2400 and **2.t** = 20.
2. Use a serial communication program (such as Windows Hyper Terminal or Procomm) to set the serial port, baud rate, data bits, etc.
3. Press **TARE** () for three seconds. The display shows **fn 00**.

4. Select function 41 or 42 (depending on which memory slot you want to use for the custom print format). Use **P.TARE** () to edit the current digit and **TARE** () to move to the next digit. When done, press **PRINT** ()



If you choose the first memory slot (by selecting function 41), and that slot already contains a custom print format to the slot, the indicator downloads a new print format and overwrites the old one. Similarly, if you choose the second memory slot (by selecting function 42), and it is already occupied, the old print format will be overwritten.

5. If the PIN code is active, the display shows `ACCESS`. Enter the PIN and press **PRINT** ()
6. The display shows `FOR 1` (if you selected function 41) or `FOR 2` (if you selected function 42). An ASCII file for the default print format is uploaded to the PC.
7. On the PC, you can open the ASCII file and edit it to create the custom print format. If you have already prepared an ASCII file for the custom print format, discard the uploaded file.
8. Use the serial communication program on the PC to transmit it to the indicator.
9. When the transmission ends, press **ESC** () on the indicator.
10. The display shows `PRN 1` briefly, and the received ASCII block is transmitted to the PC for verification. The received ticket is stored in non-volatile memory.
11. On the PC, check the ASCII block sent by the indicator, to ensure communication was successful. If not, go back to step 4.
12. If you want to download an additional custom print format (to the other memory slot) go back to step 1. Next time around, select function 42 (if you selected 41 this time), or function 41 (if you selected 42 this time).

7 Outputs and Digital Input

The VT200/220 is able to interface with weighing automation systems, using two optoisolated outputs (digital setpoints) and one digital input. There is also an analog output configuration.

- The digital outputs (setpoints) are triggered when the scale reads an upper weight threshold, defined by the user. There is a separate threshold for each setpoint.
- The analog output configuration consists of a galvanically-isolated D/A converter, generating either voltage or current output. Relevant parameters can be modified using the **ACAL** dialog (see section 7.4).
- The digital input is used as a tilt switch. When a signal is received on the input cable, the display locks for a certain period of time. The tilt switch is enabled, and its time delay defined during setup.

7.1 Specifications

7.1.1 Digital Outputs

- Transistor output open collector positive common.
- 24VDC + 10% / 100mA per output.
- Max off: State voltage 30VDC / leakage 100 μ A.
- Optoisolated to 2.5kV.
- Short-circuit protected.
- 2ms maximum delay for both on and off positions.

7.1.2 Analog Outputs

- Galvanically-isolated D/A converter.
- Circuit may be operated as current output or voltage output.
- Output is capable of driving 20mA into 1K Ω load.
- Current output values: 0-20mA, 4-20mA, 0-24mA.
- Voltage output values: 0-10V.
- Powered by an external 24VDC (stabilised +/- 10%, current rating 50 mA).

7.1.3 Digital Input (Tilt Switch)

- 9-24VDC, positive common optoisolated to 2.5KV.
- Input resistance 3.3K Ω .
- 2ms maximum delay for both on and off positions.

7.2 Connecting Digital Outputs and Tilt Switch

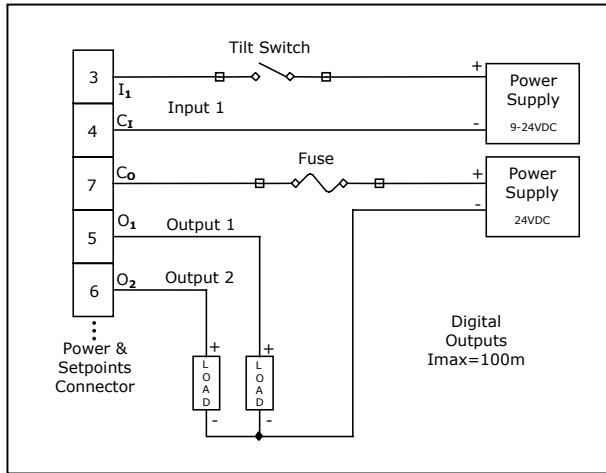

Figure 12 – Digital output and tilt switch connection diagram

7.3 Setting Thresholds for Digital Setpoints

Each setpoint has an upper weight threshold that triggers it. For example, if you set a threshold of 13kg for setpoint 1, nothing will happen as long as the items on the scale weigh less than 13kg. As soon as the weight measured reaches exactly 13kg, or more, the setpoint will be switched on (if normally off) or off (if normally on).

You can use the two setpoints to set an upper and lower range for a production operation. For example, if the weight of a product drops below the threshold for setpoint 1, or goes above the threshold for setpoint 2, it can be rejected.









Setpoints can be activated either by net weight or by gross weight, depending on setup parameter 5.6.



Setpoints can be either normally open or normally closed, depending on setup parameter 5.7.

➔ **To edit weight thresholds for both setpoints:**

1. Press **TARE** () on the front panel, and keep it pressed for around three seconds. The display shows `Fn 00`. The left zero flashes.
2. Editing setpoints is function 01, so press **→ (TARE)** to move to the second digit. It starts flashing.
3. Press **↑ (P.TARE)** once. The display should now show `Fn 01`.
4. Press **PRINT** () to confirm. The display shows `SETP 1` briefly. Then it shows the current threshold for setpoint 1. The extreme-left digit flashes.
 - If you don't want to change this threshold, press **PRINT** () and skip to step 6.
 - If you do want to change it, proceed to step 5.
5. Enter a new threshold value. To do this, press **↑ (P.TARE)** to change the current digit, then **→ (TARE)** to move to the next digit. To finish, press **PRINT** ()
6. The display now shows `SETP 2` briefly, then the current threshold for setpoint 2. The extreme-left digit flashes.
 - If you don't want to change this threshold, press **PRINT** () and skip to step 8.
 - If you do want to change it, proceed to step 7.
7. Enter a new threshold value. To do this, press **↑ (P.TARE)** to change the current digit, then **→ (TARE)** to move to the next digit. When you are done, press **PRINT** ()
8. The threshold values are saved in EEPROM memory.

7.4 Configuring Analog Output

The analog output channel allows the indicator to communicate with PLC devices, using one of the following two methods:

- Converting load cell input into voltage (0-10V).
- Converting load cell input into current (0-20mA or 4-20mA).

This feature is only active if your indicator is equipped with an optional analog output board. Section 7.4.1 below explains how to connect the analog output board, and set a hardware jumper to define which of the two output methods to use.

After connecting the board and setting the jumper, you can set analog output parameters using the **SETUP > ACAL** menu (see section 7.4.2).

7.4.1 Connecting PCB and Setting Jumper

In order to use analog output, the option PCB (PCB 761) connected it to the VT200 as follows: In the one side to **ST5** socket on the main board and in the other side using the mounting posts/spacers provided to:

Stainless steel enclosure – Main board.

Aluminum enclosure – Indicator’s rear panel (see page 80).

Jumper JP1 determines the output mode – current or voltage.

➔ **Analog output pins connections:**

1. Connect pins as follows:
 - For current output, connect pin 1 (current output, +) and pin 3 (common).
 - For voltage output, connect pin 2 (voltage output, +) and pin 3 (common).
2. Connect an external power supply of 24VDC, using pins 4 and 5:
 - Pin 4 – power in (+).
 - Pin 5 – power in (-).

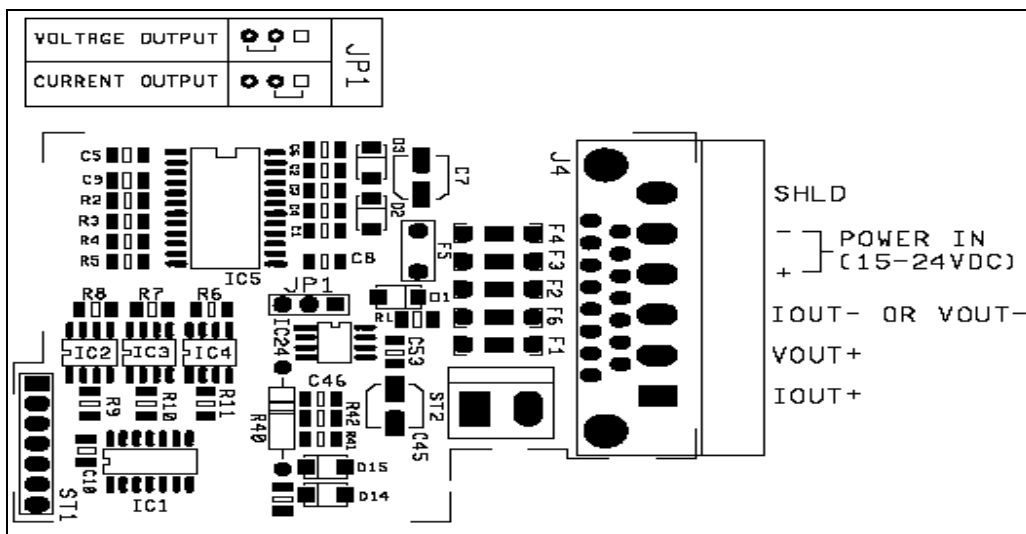

Outputs and Digital Input

Configuring Analog Output

➔ **To set output mode jumper (JP1):**

Set jumper JP1 to the appropriate position, to define voltage output or current voltage, as shown in the image below.

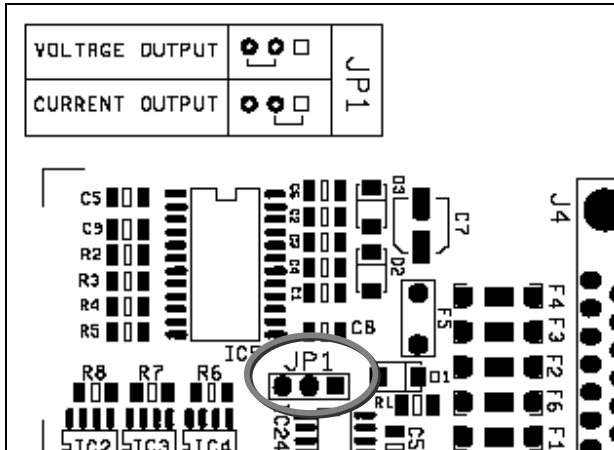

7.4.2 Setting Analog Output Parameters

The output can be set to the standard calibration, where 0 on the weight display is output as 0 mA or 4 mA, and max on the display is output as 20mA. The output is capable of driving 20mA into 1K Ohm load.

Alternatively, you can edit these zero and span calibration values. This is controlled through the **A.1** parameter, which, when set to 1, opens a dialog that allows you to enter mA values for zero and span.

There are several other analog output parameters, detailed in the table below.

Par.	Description	Values
A.1	Standard / custom zero and span. 0 specifies that the scale should output 0mA at zero input and 20mA at maximum input (or 0V at zero and 10V at max). 1 opens a dialog after A.8 that allows you to enter custom zero and span values. Press PRINT to confirm; the display shows 0 xx.xxx. Enter the D/A output at zero, in voltage or mA, and press PRINT . The display shows F xx.xxxx. Enter the D/A output at maximum input, in voltage or mA, and press PRINT .	0 = Standard (20mA max) 1 = User defined Zero and Span
A.2	Normal or absolute AOUT mode. Specifies what happens when the displayed weight is negative: analog output is either zero (normal mode) or the absolute value of the negative reading (absolute mode). For example, if the display shows -100.00, and absolute mode is set, AOUT=10mA. In normal mode, AOUT=0mA, regardless of the negative reading.	0= Normal 1 = Absolute

Par.	Description	Values
A.3	Error output level. Specifies whether scale errors should be indicated as a low or high signal.	0 = Low (0mA) 1 = High (24mA)
A.4	Current / voltage. This parameter must correspond to the hardware jumper, which defines whether output should be in current or voltage (see section 7.4.1).	0 = Current 1 = Voltage
A.5	Net / gross. Specifies whether the indicator should always output gross weight, or output net weight when tare is active.	0 = Net weight 1 = Gross weight
A.6	Effective Range for current output. Sets the range to 0-20mA or 4-20mA. Relevant only if A.4 and the hardware jumper are set to current.	0 = 0-20mA 1 = 4-20mA
A.7	Resolution. Specifies whether output should be in high resolution if the display is showing high resolution.	0 = Display 1 = Internal
A.8	Operation. Enables and disables the analog output.	0 = Disabled 1 = Enabled

7.4.3 Calibrating D/A Converter

➔ To calibrate D/A converter (0-10V):

1. Place jumper JP1 on PCB (761) for voltage output.
2. Power up the unit, enter the setup menus and enter the **ACAL** menu.
3. Set parameters as follows: **A.1=1; A.2=0; A.3=0; A.4=1; A.5=0; A.6=0; A.7=1; A.8=1.**
4. Skip D/A calibration and save the above settings by selecting **STORE**.
5. Access the function menu and select function 85 (see 3.3.1).
6. The display shows $\text{C } 00000$. Enter 65535. Press **PRINT** to output the value.
7. Use a voltmeter to measure the voltage at pins 2 (+) and 3 (-) of the analog output connector (J4). Record the value (in volts). Calculate a new value, which is: $100/\text{recorded value}$. E.g. Recorded value is 9.94, new value is $100/9.94=10.06$. This is the *full scale voltage*.
8. Exit Fn 85 and re-enter the **ACAL** menu.
9. Set parameter **A.1** to 1. The calibration dialog starts.
10. When prompted for D/A Zero, enter 00.000.
11. When prompted for D/A Span, enter the *full scale voltage* you calculated in step 7.
12. When you finish stepping through the dialog, exit the **ACAL** menu.
13. Select **STORE** to save your settings.

7.5 Using the Tilt Switch

You can set the time delay for the tilt switch function using the setup parameter **4.t**. Use this parameter to enter the time delay for display lock in 1/10 seconds. The delay may be between 1 and 90 1/10 seconds (i.e. between 0.1 and 9 seconds).

When the contacts close, the display locks after the time delay elapses. When they open again, the display unlocks after the same time delay elapses.

Set **4.t** to 00 to disable the tilt-switch function.

7.5.1 Tilt Switch Options

Parameter **4.t**, which controls the tilt switched, allows several special options, accessed by setting it above 90:

- 91 – Tare scale on the rising edge of input. Setpoints always enabled.
- 92 – Print on the rising edge of the input. Setpoints always enabled.
- 93 – Setpoints active when input is high. Setpoints inactive when input is low.
- 94 – Scale is tared at the rising edge of input. If taring is successful, setpoints are activated. If input is low, setpoints are inactive.
- 95 – When input is low, scale 1 is selected and displayed. When input is high, scale 2 is selected and displayed.
- 96 – Zero the scale.

8 Service Operations and Testing



8.1 Service Operations

The operations described below are performed by accessing the function menu (pressing the **TARE** () button for three seconds). For more detailed information on using the function Menu, see section 3.3.1.

8.1.1 Setting and Changing Calibration Password (Function 40)

The Personal Identification Number (PIN) is a password that restricts access to the calibration procedure. By default, the PIN is inactive and set to 000000. You can use the procedure below to set a secret PIN, which will prevent users and unauthorized personnel from changing calibration parameters.

➔ **To change the PIN:**

1. Access the function menu and select function 40.
2. The display shows `Pin 0` briefly, and then 000000. Enter the old PIN and press **PRINT** ()
 - If the PIN you entered is correct, the display shows `PIN 1`.
 - If you entered a wrong PIN, the unit resets. Turn it on and go back to step 1.
3. Enter the new PIN number and press **PRINT** () . The display shows `PIN 2`.
4. Re-enter the new PIN and press **ENTER**.

The new PIN is stored and the display shows `PASS` briefly. If the two entries are not the same, `FAIL` is displayed briefly and the new PIN you entered is discarded.



IMPORTANT: Make sure you do not forget the PIN entered. If the PIN is lost, the unit must be returned to the factory to initialize the PIN, and a fee will be charged.





8.1.2 Setting Date, Time and Serial Number (Function 05)

In order to set the time, the battery backed RAM and real time clock option must be installed.

This function depends on two parameters accessed through **SETUP > SETUP1**:

- Parameter 1.6 – enables and disables battery-backed RAM.
- Parameter 1.4 – specifies the date format (DDMMYY or MMDDYY).

➔ **To set date, time and serial number:**

1. Access the function menu and select function 05.
2. The display shows `dAtE` briefly, and then the date (in either of the formats `DDMMYY` or `MMDDYY`, depending on setup parameter 1.4). Edit the date, using **P.TARE** () to change the current digit, and **TARE** () to move to the next digit. When you are done, press **PRINT** ().
3. The display shows the current time in `HHmmSS` format (hours, minutes, seconds). Edit the time and press **PRINT** ().
4. The display shows the current alibi memory serial number (this number appears on tickets printed by the indicator). Edit this number and press **PRINT** ().

8.1.3 Displaying Remaining Battery Capacity (Function 02)



➔ **To display remaining battery capacity:**

Access the function menu and select function 02. The battery charge is displayed as a percentage of remaining capacity. Press **ESC** () to exit.

8.1.4 Checking Calibration Seal (Function 48)

In order to check that calibration has not been tampered with. This can be verified by means of the audit trail counter, which increments each time calibration parameters are changed, and by means of a jumper (for more information, see section 4.4). Use the procedure below to see the current value of the counter and the current position of the jumper.

➔ **To check calibration seal and audit trail counter:**

1. Access the function menu and select function 48.
2. The display shows the audit trail counter. Check to see that this counter is the same as it was after the last authorized calibration. Press **PRINT** ().
3. The display shows the status of the physical calibration seal. Press **ESC** () to exit.

8.1.5 Viewing Load Cell mV (Function 80)

➔ **To view an mV meter:**

Access the function menu and select function 80. The indicator loads calibration data, and displays mV transmitted by the load cell.

8.1.6 Viewing A/D Count (Function 81)

➔ **To view the A/D count:**

Access the function menu and select function 81. The indicator shows the analog-to-digital converter internal count. Press **ESC** () to exit.

8.1.7 View Software Version Number and Date (Function 82)

➔ **To view the number and date of the current software version:**

Access the function menu and select function 82. The indicator shows software version number and the date it was released. Press **ESC** () to exit.

8.1.8 Locking and Unlocking Keys

➔ **To lock keys:**

1. Access the setup menus and navigate to **SETUP > SETUP 6**.
2. Set one or more of the following parameters to 1:
 - 6.1 – **SCALE**
 - 6.2 – **ZERO**
 - 6.3 – **TARE**
 - 6.4 – **P.TARE**
 - 6.5 – **PRINT**
 - 6.6 – **TOTAL**
 - 6.7 – **PCS**

Keys you lock will not work (i.e. if a user presses them nothing will happen) until you unlock them.

➔ **To unlock keys:**

1. Access the setup menus and navigate to **SETUP > SETUP 6**.
2. Set the corresponding parameter to 0 (see the bulleted list above).

8.2 Testing the Indicator

8.2.1 Testing ROM/RAM Integrity (Function 86)

In order to check the integrity of the unit's ROM and RAM use the procedure below.

Note that partly-corrupted memory does not necessarily affect indicator's operations, and can be corrected. To learn how to correct memory errors, see the *VT200/220 User's Guide*, section 7.3.

Testing the Indicator

➔ **To test ROM/RAM integrity:**

1. Access the function menu and select function 86.
2. One of the following messages are displayed:
 - `Err 01` – indicates that ROM data is corrupted.
 - `Err 02` – indicates that RAM data is corrupted.
 - `PASS` – indicates that both ROM and RAM memory units are okay.

8.2.2 Testing the Keypad and Display (Function 90, 91)

➔ **To test that the display is working properly:**

Access the function menu and select function 90. All digits display 0 through 9, in sequence, and then all characters are displayed in sequence.

➔ **To test that the keypad is working properly:**

Access the function menu and select function 91. The display blanks. When you press a key, the scan code for that key is shown on the display. The scan codes are as follows:

- 30 – **SCALE**
- 32 – **TARE**
- 33 – **P.TARE**
- 34 – **PRINT**
- 35 – **TOTAL**
- 37 – **PCS**

8.2.3 Testing Digital Input and Outputs (Function 93)

➔ **To test digital input and outputs (setpoints):**

1. Access the function menu and select function 93.
2. The display shows the status of the inputs and outputs, as follows:
 - The first digit from the left displays data received on the digital input channel.
 - The fifth digit from the left displays data sent on output 1.
 - The sixth digit from the left displays data on output 2.
3. Press **TOTAL** () to toggle output 1 on and off. When it is on, the data sent should be displayed in the fifth digit. If the output connects to another device, check if the signal was received.

4. Press **PCS** () to toggle output 2 on and off. When it is on, the data sent should be displayed in the sixth digit. If the output connects to another device, check if the signal was received.
5. Connect a device to the digital input, and send a signal. See if the data appears in the first digit.

8.2.4 Testing the Print Buffer (Function 94)

➔ **To test the print buffer:**

Access the function menu and select function 94. An ASCII file (30h-7Fh) is output to the printer port, with error control.

8.2.5 Testing Data Received on Both Serial Ports (Function 96)

➔ **To test data received on one or both serial ports:**

1. Access the function menu and select function 96.
2. The display shows data received on COM ports, as follows:
 - The two digits on the left (first and second digits) show data received on COM 1.
 - The two digits on the right (fifth and sixth digits) show data received on COM 2.
3. Connect a PC or another device to one or both of the indicator's ports, and begin transmitting data. Watch the display to see if the data is received properly.





9 Troubleshooting









The indicator has no serviceable parts. Authorized technicians may:

- Respond to errors shown on the display (see chapter 9.1).
- Check load cell connections (see chapter 9.2).
- Check the power supply (see chapter 9.3).
- Check the digital outputs (see chapter 9.4).

9.1 Errors, Causes and Remedies

When an error or an unexpected event occurs, the indicator displays the message `Err xx`, where `xx` is the error code. The following table explains all the error codes and suggests what to do when each error message is displayed.

Error code	Possible cause	Actions to be taken
Err 01	Faulty EPROM memory.	Contact manufacturer.
Err 02	Faulty CMOS RAM.	Contact manufacturer.
Err 04	Calibration data corrupted due to faulty EEPROM.	Contact manufacturer.
Err 05	The scale is not connected properly, or the analog-to-digital converter is faulty.	Check the scale, cable and connectors. If these are okay, contact manufacturer.
Err 06	Insufficient power.	Check the indicator's power supply.
Err 15	The indicator has been powered on after an irregular shutdown: A power failure or a soft reset.	Press ZERO ()
Err 16	System time is wrong.	Enter a new date and time. Refer to section 8.1.2.
Err 20	The printer is not online because it is not connected, not turned on, out of paper, or for some other reason.	Make sure the printer is connected and operational, and press PRINT () to retry. If you can't bring the printer online, and you would like to use the indicator anyway, press ZERO ()
Err 26	Printer has no paper.	Add paper to the printer, and press PRINT () to retry. If you can't add paper, and you would like to use the indicator anyway, press ZERO ()

Error code	Possible cause	Actions to be taken
Err 30	The host PC is not connected, or the communication link failed.	Make sure the computer is connected, and press PRINT () to retry. If there is some problem with the computer, but you would like to use the indicator anyway, press ZERO ().
Err 33	The host PC did not return a proper response (an acknowledgement required by the communication protocol).	Make sure the computer is connected, and press PRINT () to retry. If there is some problem with the computer, but you would like to continue using the indicator anyway, press ZERO ().
Err 50	Sample used in counting has too few items.	Remove the units from the scale and press ZERO (). Try to weigh a heavier group of units.
Err 51	Sample used in counting weighs too little.	Remove the item/s from the scale and press ZERO (). Try to weigh a heavier item.
Err 55	Alibi memory full. The memory serial number resets to 0000. From now on, each new memory entry overwrites the oldest record in alibi memory.	Press ZERO ().
Err 56	Printing error. Tare is currently active, but selected print format does not support net weight.	Printout aborted. Printing stops and returns to Weighing Mode.
Err 57	The weight measurement could not be saved to alibi memory.	Press ZERO ().
Err 67	The area of memory that stores the accumulated total weight is corrupted.	Print/reset the total weight
Err 69	The area of memory that stores the accumulated total weight has overflowed. In other words, the total weight is too large.	Print/reset the total weight

9.2 Checking Load Cell Connection

If there appears to be a problem with the load cell connection:

- Check input and output resistance.
- Check resistance between any terminal and shield.
- Check load cell connection and cable.

9.3 Checking Power Supply

If the unit does not turn on:

- Check 9-15VDC power supply.
- Check the resettable fuse F4 on PCB 801.

9.4 Checking Digital Outputs

If the setpoints are not working properly:

- Test the setpoints (see chapter 8.2.3).
- Check 24VDC power supply.
- Check the resettable fuse F3 on PCB 801.

Appendix A: Technical Drawings

i. System Block Diagram

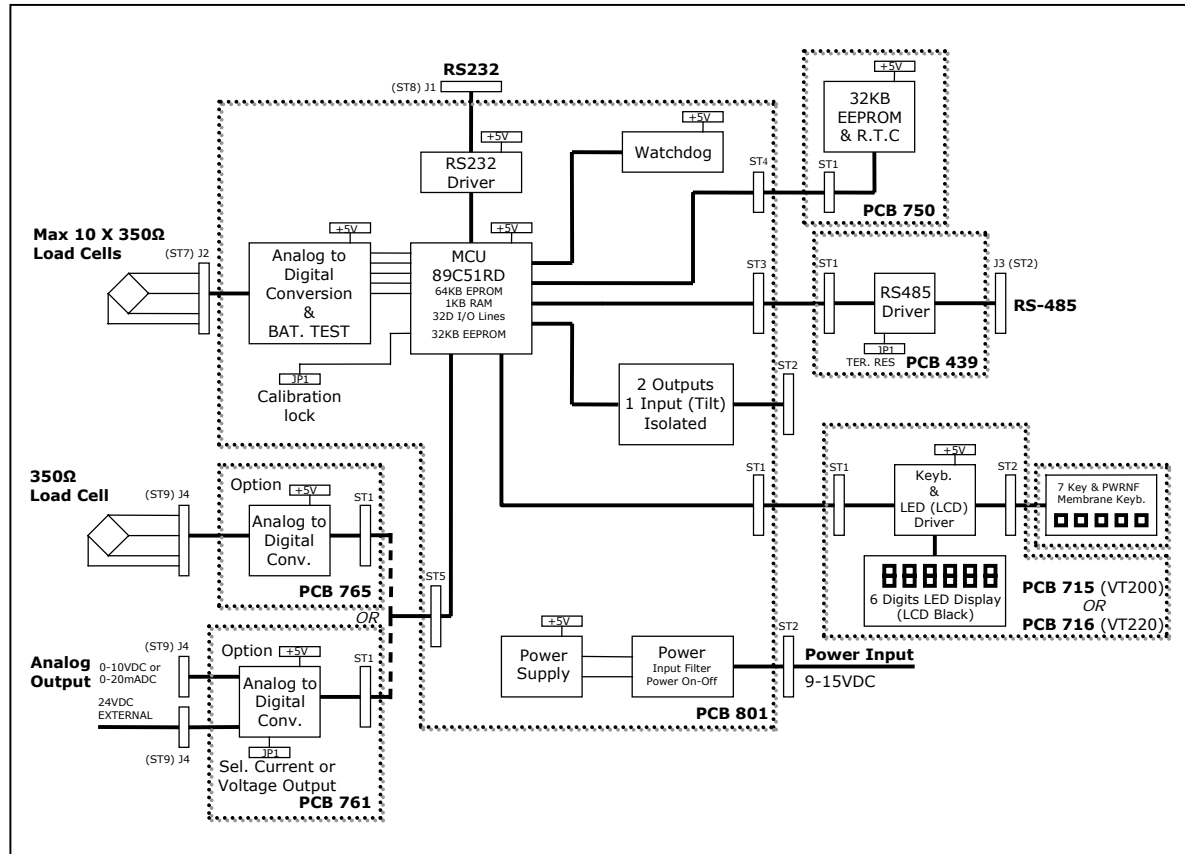

Appendix A: Technical Drawings

ii. Rear Panel Connections (Desktop Model)

ii. Rear Panel Connections (Desktop Model)

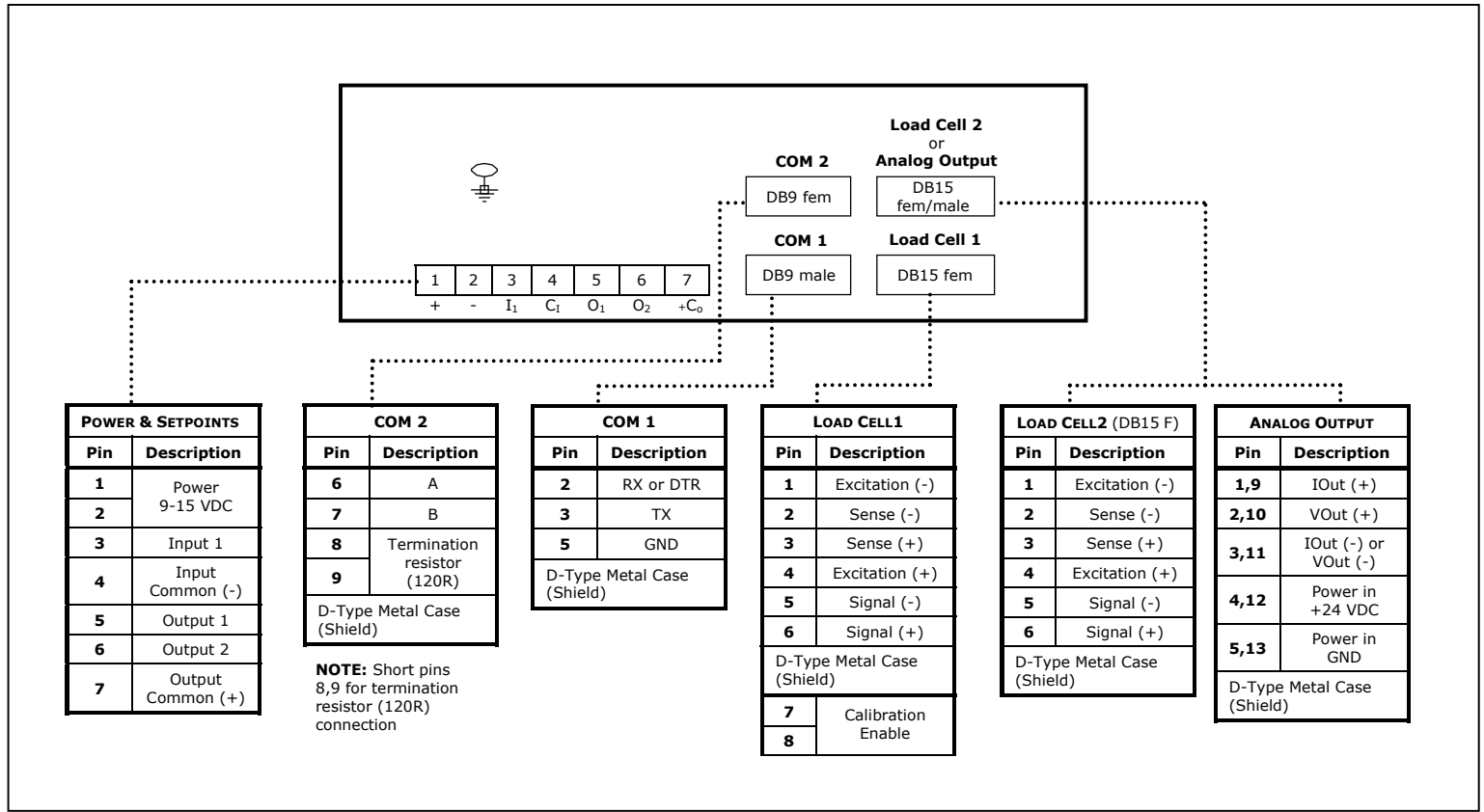

iii. Terminal Connections (Wall-Mount Model)

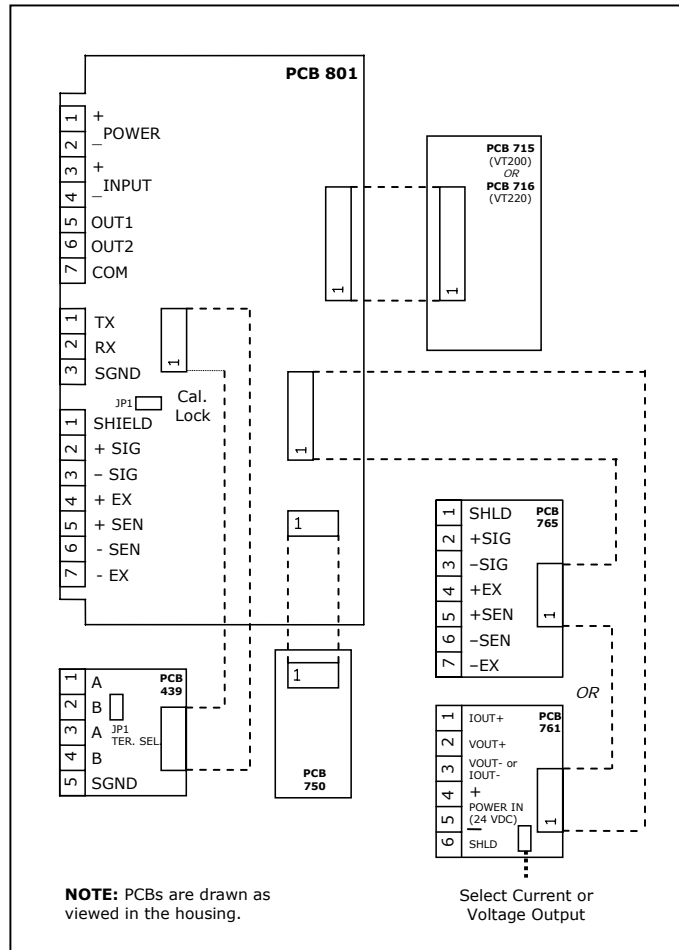

iv. Cabling Diagram

iv. Cabling Diagram

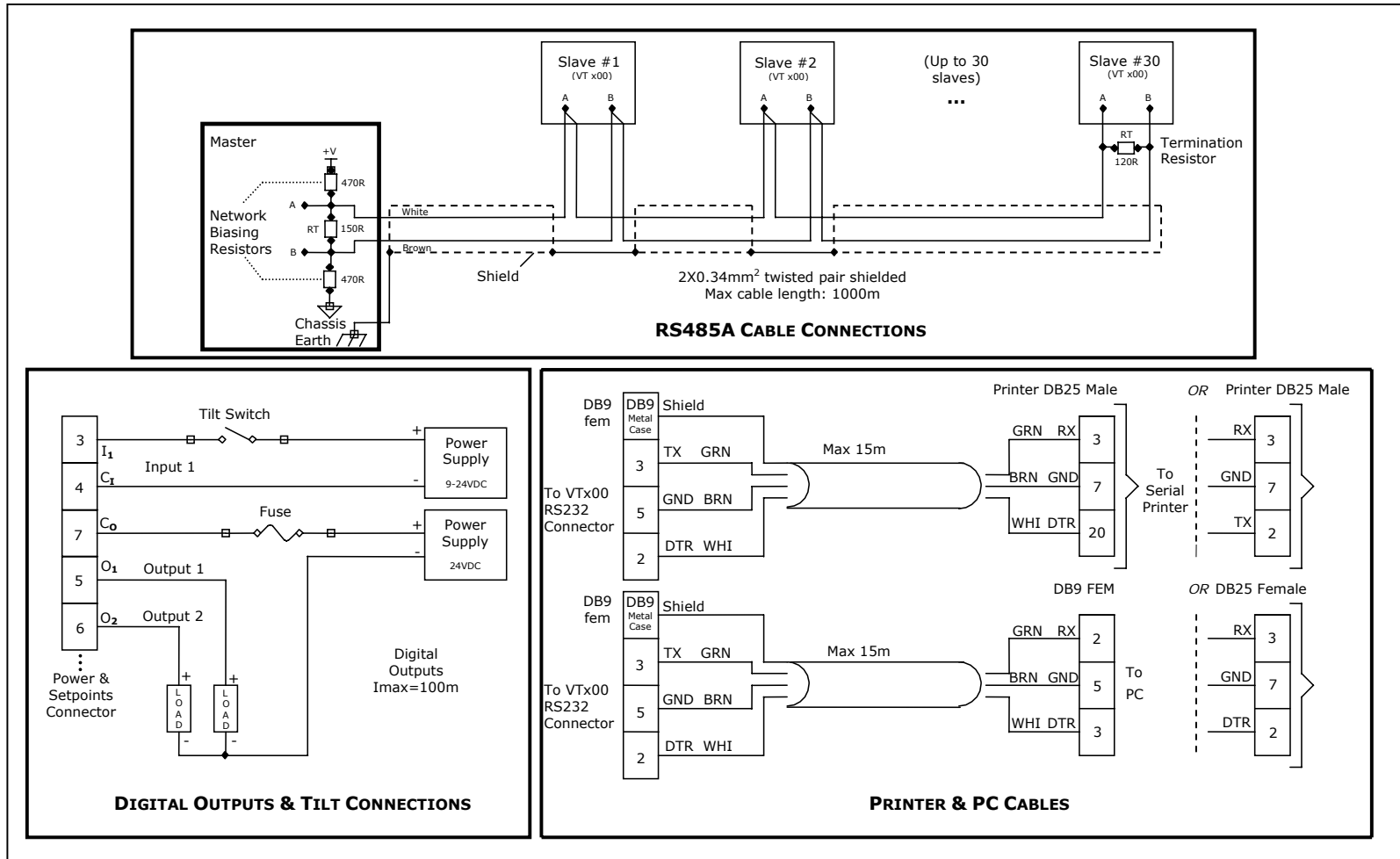

v. Printed Circuit Boards

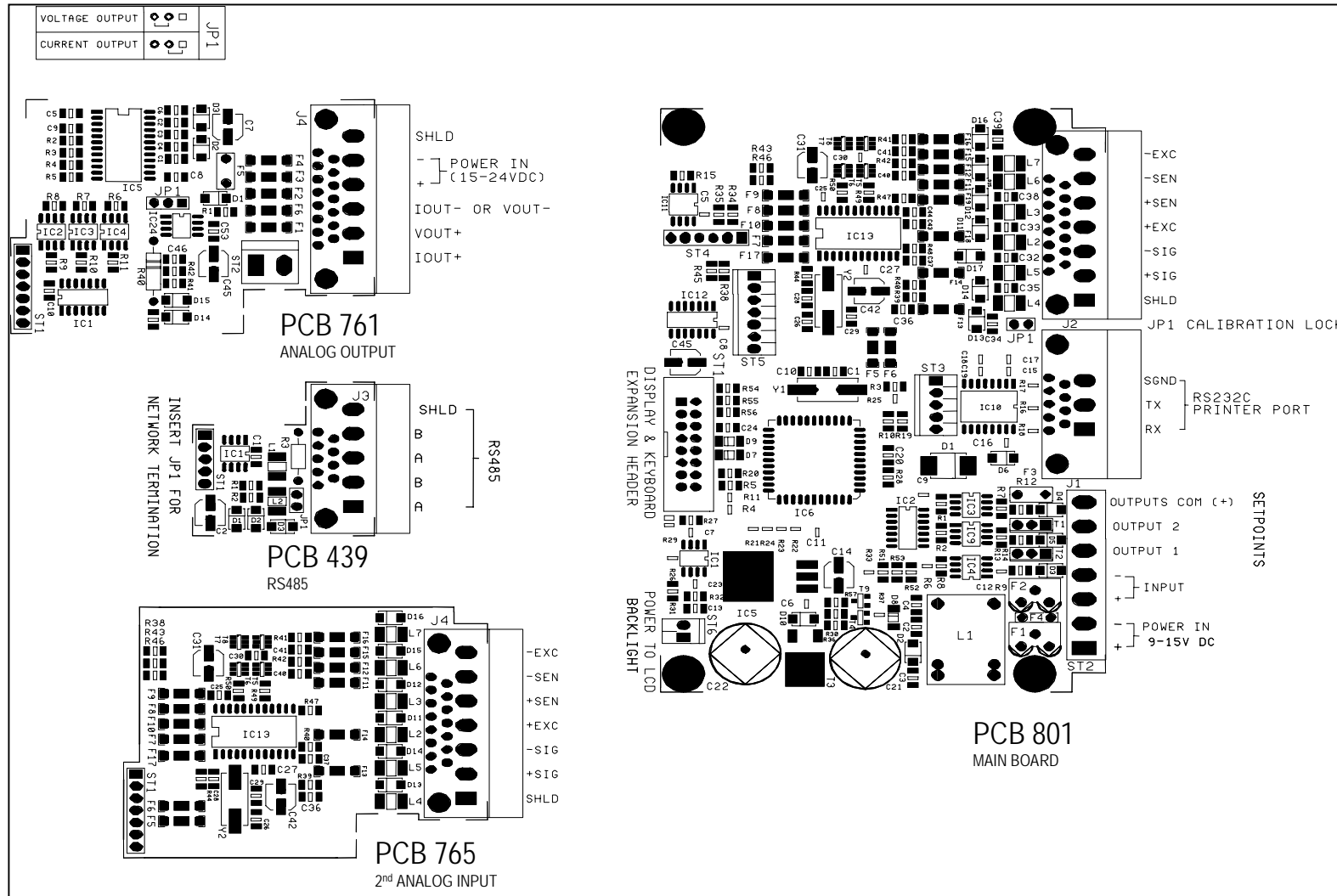

Contacting Vishay Transducers

USA

Vishay Transducers Americas

801 Sentous Avenue City of industry, CA 91748 USA
PH: +1-800-872-4784; +1-626-363-7500
FAX: +1-626-332-3418
E-MAIL: vt.us@vishaymg.com

Israel

Vishay Transducers Israel

8A Hazoran Street, P.O. Box 8381,
Netanya 42506, Israel
PH: +972-9-863-8888
FAX: +972-9-863-8800
E-MAIL: vt.il@vishaymg.com

Asia

Vishay Transducers Taiwan (Asia except China)

15 Fl, No. 86, Sec. 1 Sintai 5th Rd.
Shijr City, Taipei, 22102, Taiwan R.O.C
PH: +886-2-2696-0168
FAX: +886-2-2696-4965
E-MAIL: vt.roc@vishaymg.com

Vishay Transducers China

No. 5 Binguan Nan Dao Youyi Rd., Hexi District,
Tianjin China, Code 300061
PH: +86-22-2835-3503
FAX: +86-22-2835-7261
E-MAIL: vt.prc@vishaymg.com

Europe

Vishay Transducers Germany

Tatschenweg 1, 74078
Heilbronn, Germany
PH: +49-7131-39099-0
FAX: +49-7131-39019-229
E-MAIL: vt.de@vishaymg.com

Vishay Transducers UK

Stroudley Road, Basingstoke, Hampshire
RG24 8FW, United Kingdom
PH: +44-125-646-2131
FAX: +44-125-647-1441
E-MAIL: vt.uk@vishaymg.com

Vishay Transducers France

16 Rue Francis Vovelle, 28000 Chartres, France
PH: +33-2-37-33-31-20
FAX: +33-2-37-33-31-29
E-MAIL: vt.fr@vishaymg.com

Vishay Transducers Netherlands

Ramshoorn 7, P.O Box 6909, 4802 HX Breda
The Netherlands
PH: +31-76-548-0700
FAX: +31-77-541-2854
E-MAIL: vt.nl@vishaymg.com