

Virtual Measurements & Control



VC200 Series Setup Manual
Revision F

Safety Notice	2
Specifications	3
VC201 Front Panel	4
VC202/VC203 Front Panel	4
Status Indicators.....	5
Key Functions Group ‘A’	6
Optional Key Functions Group ‘B’	7
Operating Instructions	8
Configuration Mode Key Functions	10
Setup/Configuration Mode Access.....	11
Configuration/Calibration Mode	11
Configuration/Calibration Menu Choices	12
Calibration Audit Trail	18
Input/Output Connections.....	19
Jumpers, Headers and Terminal Blocks Location	21
Error Messages	22
Jumper Settings.....	22
Customizing Print Format (Optional)	23
Date and Time Settings Operation	30
Display Character Reference	33
ASCII Character Set.....	34

USA

Virtual Measurements & Control, Inc.
1040A N. Dutton Ave, Santa Rosa,
CA 95401, USA
Tell: (707) 573 3111, Fax: (707) 573 3113
Website: <http://www.virtualmc.com>

ASIA

Virtual Measurements & Control (Asia) Pte. Ltd.
24, Hillview Terrace,
Singapore 669235
Tel: (65) 6762 5522, Fax: (65) 6763 6656
Email: sales@virtualmc.com

Safety Notice

It is important that VMC's equipment is installed and operated in such a way that all applicable safety requirements are met. It is your responsibility as a user to ensure that you identify the relevant standards and comply with them. Failure to do so may result in damages to equipment and personal injury. In particular, you should review the contents of the Setup Manual carefully before installing or operating the equipment.

This equipment is not designed for placement in hazardous or explosive environments that require Factory Mutual Approval.

Under no circumstances will the supplier of the equipment be liable for any incidental, consequential, or special damages of any kind whatsoever, including but not limited to lost profits arising from or in any way associated with the use of the equipment or this Setup Manual.

Specifications

Internal Resolution	1,000,000 counts at 3mV/V
Display Resolution	Selectable (1/10,000 NTEP approved)
Input Sensitivity	1 μ V/graduation typical, 0.4 μ V/graduation minimum
Display Increments	Selectable x1, x2, x5, x10, x20, x50, x100
Decimal Point	Selectable 0 ~ 4
Display	7 Digits 7-Segment LED display, 14.2mm (0.56") high, with annunciators (7 LED lamps) for function select, Stable, Center Zero, Net, Print, kg, lb, and Low Battery display
Keyboard	Standard - 6 button tactile keypad including Power On/Off key Optional - 18 button tactile keypad including Power On/Off key
Audio Alarm	Tone for key entry confirmation and low battery alarm
A/D Conversion Rate	7.5 updates per second
Load Cell Excitation Voltage	9.7VDC or 5VDC selectable. Drive up to six 350 ohm load cells
Analog Input Range	0.2mV/V to 3.0mV/V maximum
Non-Linearity	0.01% of full scale or less
Over Capacity	Display "CAP OL" when exceeds full scale capacity
Tare	Standard - Pushbutton tare Optional - Pushbutton tare, numeric tare entry & 10 predefined tare recall
Auto Zero Tracking	Selectable to 3.0 d by 0.5 d step
Motion Window	Key in data 0..255 (1 = 0.5 d)
Calibration Method	Software – Menu driven prompting
Units of Measure	Selectable kg/lb/g/oz, up to 2 units displayable
RFI/EMI Protection	All signal and excitation lines filtered to –65db min. @ 500MHz
Filtering	Selectable digital filter
RS-232C data output	COM Port 1. Full Duplex or Bi-directional COM Port 2. Simplex or Unidirectional (output only) Selectable baud rates (1200,2400,4800,9600,19200), manual or auto print, continuous data out or bi-directional communication
Remote Display	Standard – Remote only Optional - Programmable as Main Indicator or Remote Display
Custom Print Format	Programmable, up to 119 characters for Custom Print Format and up to 23 characters for Continuous Print Format
Set Points	Standard - None Optional - Selectable up to 2 Set Points for Low and High limit settings
Power	100/115VAC or 220/230VAC, 50-60Hz, 6VA with built-in Charger for 12VDC 2-2.3AH Rechargeable Sealed Lead Acid Battery (Battery Dimension 67 (H) x 178 (W) x 34 (D) mm, is optional)
Current Consumption	100mA + 30mA per 350 ohm load cell
Operating Temp	-10 degrees C to + 40 degrees C
Relative Humidity	Maximum 90% RH, Non-condensing
Dimensions	150 (6")H x 230 (9.1")W x 100 (4")D mm - ABS (Standard) 140 (5.5")H x 230 (9.1")W x 90 (3.5")D mm - Stainless Steel (Optional)
Shipping Weight	2.7lb (5.1lb with optional battery) – ABS (Standard) 4.7lb (7.1lb with optional battery) – Stainless Steel (Optional)
Enclosure	ABS plastic Casing, Optional Stainless Steel, NEMA 4-X
Warranty	One Year Limited Warranty

VC201 Front Panel

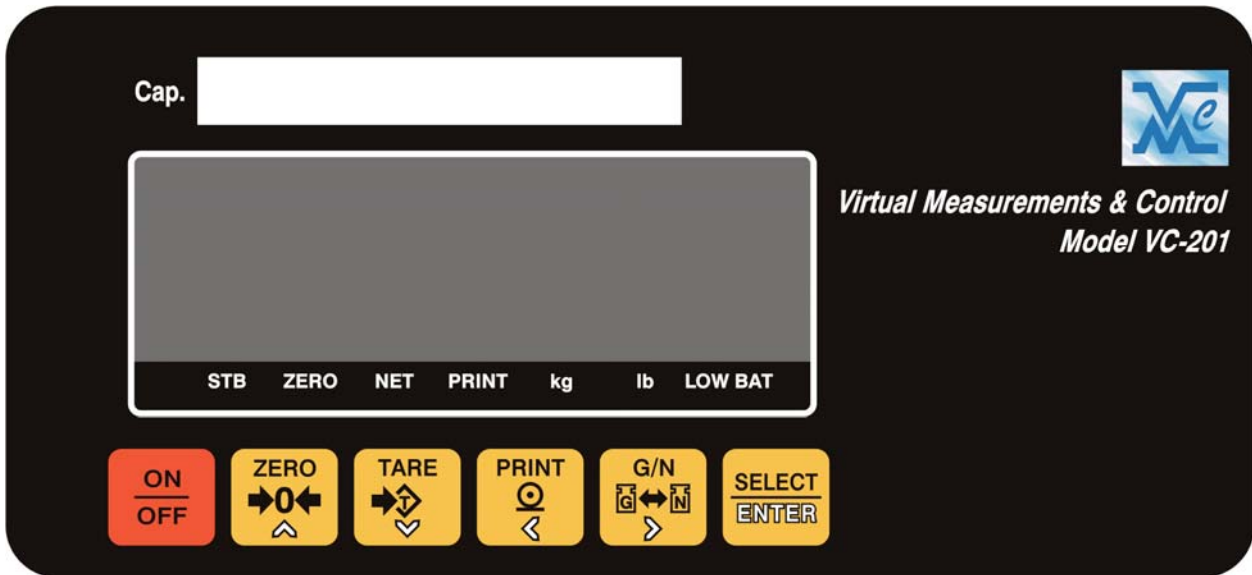

VC202/VC203 Front Panel

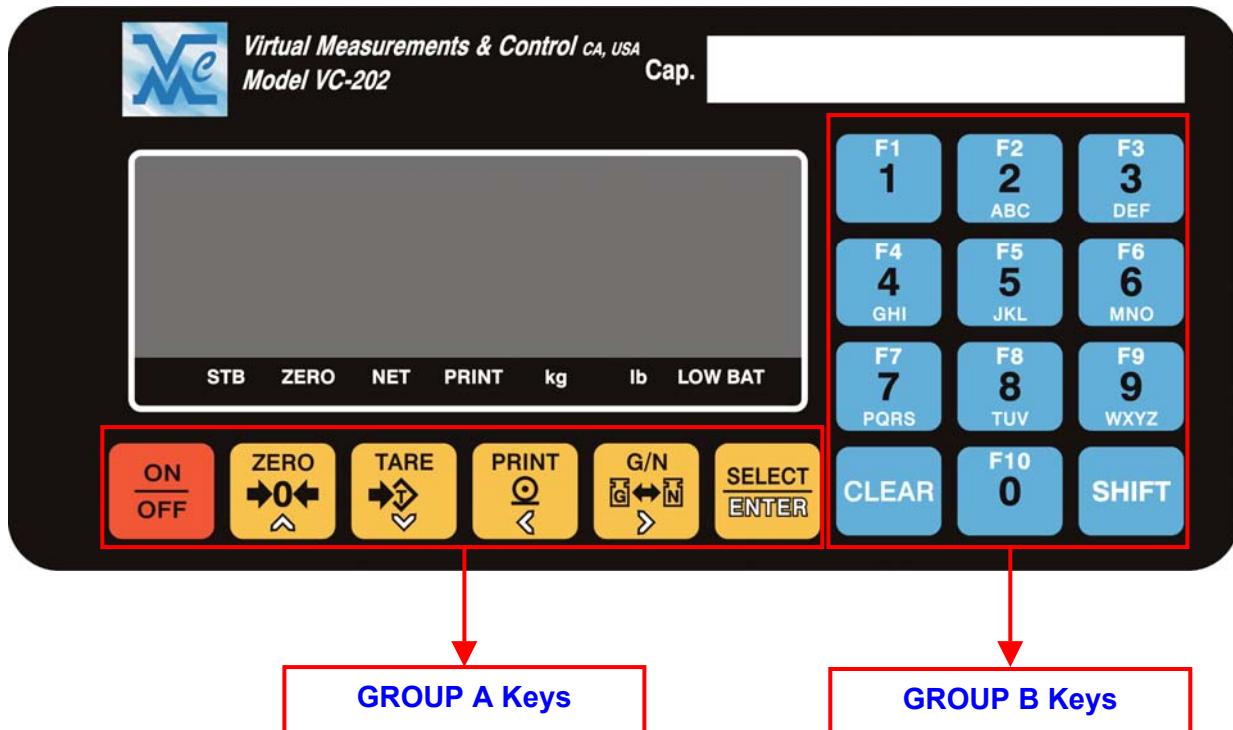

Status Indicators

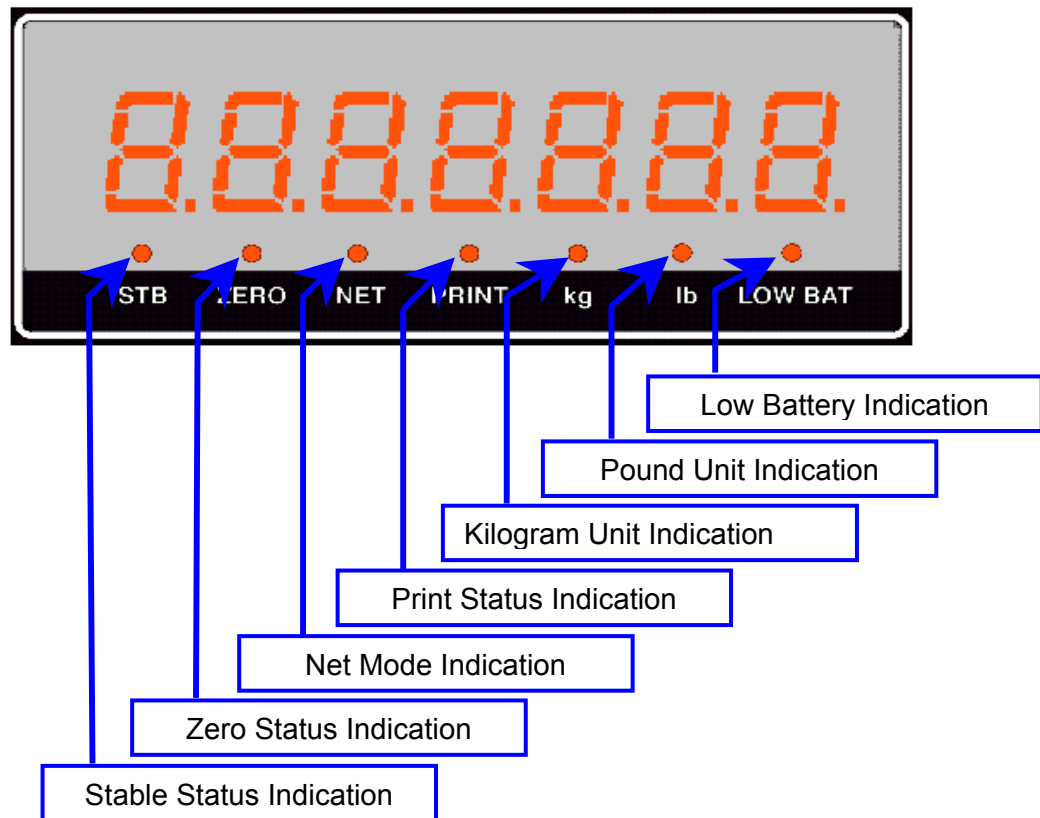

There are 7 LED indicators just below the 7-segment weight display with the following functions.

- STB – (Stable Indicator) Indicates there is no weight motion on the weighing platform.
- ZERO- (Center Zero Indicator) Indicates the weight is at center of zero.
- NET-(Net Weight Indicator) Indicates the currently displayed weight is a net weight (a tare value is active).
- PRINT-(Print Indicator) Flashes to indicate a successful print transmission.
- Kg-(Kilogram Indicator) Indicates the current weight unit is kilograms.
- Lb-(Pounds) Indicates the current weight unit is pounds.
- LOW BAT-(Low Battery) Indicates the battery is low during battery operation. In the setup mode, the blinking of this LED is an indication to enter a numeric value.

Key Functions Group 'A'



ON / OFF – Power switch.



ZERO – Zero button used to zero the indicator when the weight display is stable.



TARE – Tares the indicator when the weight display is stable.



PRINT – Initiates a print transmission when the weight is stable.



G/N - Toggles the displayed weight between net and gross.



Select / Enter – Toggles between the selected units of measure.

Optional Key Functions Group 'B'

F10
0 '0' / **F10** - Enters '0', space, Double Quotation Mark or Back Slash depending upon the current mode of operation.

F1
1 '1' / **F1** – Enters '1' dash, period, forward slash, right and left parenthesis. This key also represents Tare Register No. 1.

F2
2
ABC '2' / **F2** - Enters '2', 'A', 'B' or 'C' depending upon the current mode of operation. This key also represents Tare Register No. 2.

F3
3
DEF '3' / **F3** – Enters '3', 'D', 'E' or 'F' depending upon the current mode of operation. This key also represents Tare Register No. 3

F4
4
GHI '4' / **F4** - Enters '4', 'G', 'H' or 'I' depending upon the current mode of operation. This key also represents Tare Register No. 4.

F5
5
JKL '5' / **F5** - Enters '5', 'J', 'K' or 'L' depending upon the current mode of operation. This key also represents Tare Register No. 5.

F6
6
MNO '6' / **F6** – Enters '6', 'M', 'N' or 'O' depending upon the current mode of operation. This key also represents Tare Register No. 6.

F7
7
PQRS '7' / **F7** - Enters '7', 'P', 'Q', 'R' or 'S' depending upon the current mode of operation. This key also represents Tare Register No. 7.

F8
8
TUV '8' / **F8** - Enters '8', 'T', 'U' or 'V' depending upon the current mode of operation. This key also represents Tare Register No. 8.

F9
9
WXYZ '9' / **F9** – Enters '9', 'W', 'X', 'Y' or 'Z' depending upon the current mode of operation. This key also represents Tare Register No. 9

CLEAR **Clear** – Clear entry or backspace depending upon the current mode of operation.

SHIFT **Shift** - Selects function keys or toggles alpha or numeric entry depending on the current mode of operation.

Operating Instructions

❑ **Power ON Zeroing**

Upon applying power the instrument will:

- i) If the applied load is less than or equal to 2% of the calibration zero point the instrument will establish zero and clear any tare values.
- ii) If the applied load is greater than 2% of the calibration zero point the instrument will display “- - - - -”. The load may be removed to allow for automatic zeroing (above) or a manual zero may be established by pressing the ‘Zero’ button. Note: If the instrument has been configured to not allow for zeroing greater than 2% removing the load will be necessary.

❑ **Zeroing**

To zero the scale press the **[Zero]** button.

- i) 2 % Zeroing
 - (1) This mode will allow pushbutton zero up to 2% of full scale capacity. The available scale capacity will not be affected by the zeroed amount.
- ii) 100 % Zeroing
 - (1) This mode will allow pushbutton zero up to 100% of full scale capacity. The available scale capacity will be reduced by the zeroed amount.

❑ **Pushbutton Tare** (If enabled)

Place the object to tare on the scale and press the **[Tare]** button. The weight will be established as tare and the weight mode will switch to net.

❑ **Tare by Numeric Key** (VC202 & VC203, if enabled)

Key in the tare value using the numeric keys then press **[Tare]**. In sealed applications this function is only permitted when the gross weight is at zero.

- ❑ **Programming Recall Tare Values** (VC202 & VC203, if enabled)
 - (1) The VC202 & VC203 can maintain up to 10 predefined Tare values.
 - (2) To program a tare value press [**Shift**] and then [**8**]. The display will prompt [T 0-END] and then [t no. 1]
 - (3) Key in the desired tare register number (1-10) and press [**Enter**].
 - (4) The display will prompt [T XXX.XX]
 - (5) Enter the desired tare value.
 - (6) To Exit programming tare registers, enter '0' at the tare register prompt.

- ❑ **Recalling a Tare Value** (VC202 & VC203, if enabled)

Enter the desired tare register (1-10) then press the [**Select/Enter**] key. In sealed applications this function is only available when the gross weight is at zero.

- ❑ **Preset Output Settings** (VC202 & VC203, if enabled)

Press [**SHIFT**] then press [**9**],

The display will prompt [**S XXX.XX**]. Key in the Start value for Set point 1 and press [**Enter**],

The display will prompt [**E XXX.XX**]. Key in the End value for Set point 1 and press [**Enter**]

Repeat the above sequence for Set point 2.

Configuration Mode Key Functions



Zero - Terminates the setup mode or exits numeric entry without changing the last value



Tare - Not in use.



Print – Scroll forward through setup choices or increase the available parameter value.



G/N – Scroll backward through setup choices or decrease the available parameter value.



Select/Enter - Accept the current value or choice. Pressing quickly this key will advance next setup sub-menu. Use at the “END” prompt to save and exit setup.

The VC202 & VC203 allow numeric data to be entered via the Group B keys.

Setup/Configuration Mode Access

There are two ways to access the Setup/Configuration Mode:

- 1) Using the Calibration Jumper (JP1)
 - i) Turn off the instrument and insert Jumper 1 (JP1).
 - ii) Turn the instrument on, the display will show the Audit Trail then prompt for password entry [P 0].
 - iii) Enter the password “2001” and press the **[Enter]** key.
- 2) “Hot Key” entry if enabled (*C1.2 is set to Enable.*)
 - i) Press the **[G/N]** and **[Enter]** keys together while in normal operation mode
 - ii) The display will show the Audit Trail then prompt for password entry [P 0].
 - iii) Enter the setup/calibration password and press the **[Enter]** key.

Configuration/Calibration Mode

Category Selection:

The setup mode is arranged into major categories and their individual selections. Upon entering the setup mode the display will prompt ‘C1’ indicating category ‘1’. Using the ‘Print’ and ‘G/N’ keys scroll through the setup categories until the desired category is displayed. When the desired category is displayed press the ‘Enter’ key to begin setup. Pressing ‘Zero’ while in the category menu will prompt ‘END’, pressing ‘Enter’ at this prompt exits the setup menu.

Setup Selection:

After entering the desired category use the ‘Print’ and ‘G/N’ keys to toggle setup choices or alter setup values. Press ‘Enter’ to accept when the desired value is displayed to save the value and advance to the next selection.

Note: Features requiring the Group B Function keys will not be available when configuring the VC201

Configuration/Calibration Menu Choices

- ❖ **C1 Misc.**
 - C1.1 [DPM] Display Mode
 - C1.2 [HKY] Hot-key
 - C1.3 [ATS] Auto Power Off Time
 - C1.4 [DTM] Power On Countdown Date/Time Settings Enable
 - C1.5 [JPR] Journal Printer: Sub Total, Grand Total Functions Enable
- ❖ **C2 Key Enables**
 - C2.1 [UNE] Unit Toggle Key Enable
 - C2.2 [TAM] Tare Key Mode
 - C2.3 [TZE] Allow Keyboard Tare and Recall Tare at Zero
 - C2.4 [PS1] Preset Output 1 Enable
 - C2.5 [PS2] Preset Output 2 Enable
- ❖ **C3 Communications**
 - C3.1 [ADR] Instrument Address
 - C3.2 [CHN] Communication Channel (Port)
 - C3.3 [BDR] Baud Rate Selection
 - C3.4 [PAR] Data Bits and Parity
 - C3.5 [TYP] Serial Type
 - C3.6 [PFM] Print Format
 - C3.7 [PRM] Print Mode
 - C3.8 [MIN] Minimum Print Value
 - C3.9 [CHW] Weight Change Window
- ❖ **C4 Filter / Motion**
 - C4.1 [AVG] Average (Digital Filter)
 - C4.2 [MOW] Motion Window
 - C4.3 [MOT] Motion Time
- ❖ **C5 Pre-Calibration**
 - C5.1 [CUN] Calibration Unit
 - C5.2 [SUN] Secondary Unit
 - C5.3 [MET] Metrology Method
 - C5.4 [DP] Decimal Position
 - C5.5 [CAP] Capacity
 - C5.6 [DIV] One Division Increment Size
 - C5.7 [AZT] Auto Zero Tracking
- ❖ **C6 Calibration**
 - C6.1 [REF] Reference Calibration Mode
 - C6.2 [PCAL] Zero Point Calibration (Reference Calibration)
 - C6.3 [CAL] Span Calibration
- ❖ **C7 Calibration Tune**
 - C7.1 [TUN] Calibration Tune
 - C7.2 [DIR] Direction
- ❖ **C10 Print Formatting (Full Keypad Option Only)**
 - C10.1 [P1 CUST] Edit Custom Print Format
 - C10.2 [P2 CONT] Edit Custom Continuous Output Format
 - C10.3 [FMT END] Exit from Custom Format Editing

☐ Default settings are highlighted.

Category Selection	Values	Description	
C1	Firmware Function Settings		
C1.1	DPM	Display Mode	
	WET	Normal Weighing Mode Display	
	ADC	A/D Raw Counts Display	
	BAT	Battery Voltage Display	
	RDP	Secondary Remote Display Unit (Requires VC202 or VC203 unit to be setup as Main Display Unit with C3.6 "PFM" = RDP)	
		Connecting the Remote Displays Communication Channel 1 (COM1) to the Main Displays COM1 allows remote key entry	
	ROP	Secondary Remote Operation Unit. This setting will allow the remote access of Display, Keyboard and Printer from/to a Main Unit. Requires VC202 or VC203 unit to be setup as a Main Unit with the Remote Printer Type on COM1 (C3.5 "TYP"=RP) and a desired Print Format (C3.6 "PFM"=SIN, MUL or CPR)	
Also requires Bi-directional Communication between Main and Remote Units (COM1 ←→COM1) and a Printer is attached to this Remote Unit on COM2 with a Baud Rate setting in C3.3			
C1.2	HKY	Hot-key Enable (Allows front panel password entry to setup)	
	D	Disabled	
	E	Enabled	
C1.3	ATS	Auto Power Shutdown (Off) Time (In Battery Operated Mode)	
	1~255	1 = 1 minute	
	0	Auto Power Shutdown Disabled	
C1.4	DTM	Power On Count Down Date/Time Settings Enable	
	D	Disabled	
	E	Enabled	
C1.5	JPR	Journal Printer: Sub Total, Grand Total Functions Enable	
	D	Disabled	
	E	Enabled	
C2	Function Keys Enable		
C2.1	UNE	Allow Unit Key Toggle	
	D	Disable	
	E	Enable	
C2.2	TAM	Tare Key Mode	
	D	Disable	
	P	Enable Push Button Tare Key (Default for VC201)	
	N	Enable Numeric Tare Entry (Optional)	
	NP	Enable Numeric Tare Entry and Pushbutton Tare (Optional)	

Configuration Step	Values Set	Description
C2.2	R	Enable Recall Tare (Optional)
	RP	Enable Recall Tare and Pushbutton Tare (Optional)
	RN	Enable Recall Tare and Numeric Tare Entry (Optional)
	RNP	Enable (Recall Tare, Numeric Tare and Push Button Tare) (Default for VC202 & VC203)
C2.3	TZE	Allow Keyboard Tare and Recall only at zero
	D	Disable (Tare and Recall available at any weight)
	E	Enable (Tare and Recall available only at zero)
C2.4	PS1	Preset 1 Output Enable
	OFF	Disable
	A0	Enable with normally Inactive Output Signal
	A1	Enable with normally Active Output Signal
C2.5	PS2	Preset 2 Output Enable
	OFF	Disable
	A0	Enable with normally Inactive Output Signal
	A1	Enable with normally Active Output Signal
C3	RS-232C Communications and Printings	
C3.1	ADR	Instrument Address (to be used with external RS-232 / RS-485 Level Converter)
	0~255	Default = 0
C3.2	CHN	RS-232C Communication Port Selection
	CH_	Leave selection blank exit communications setup If CH1 or CH2 is selected continue Steps C3.3 through C3.9
	CH1	Setup channel one
	CH2	Setup channel two
C3.3	BDR	Baud Rate Selection
	12	Baud Rate Set to 1200
	24	Baud Rate Set to 2400
	48	Baud Rate Set to 4800
	96	Baud Rate Set to 9600
C3.4	192	Baud Rate Set to 19200
	PAR	Data Bit Size and Parity Setting
	8N	8 Data Bit – No Parity
	7E	7 Data Bit - Even Parity
C3.5	7O	7 Data Bit - Odd Parity
	TYP	Serial Type – Serial or Printer
	SR	Default setting for channel 1 (Serial)
	PR	Default setting for channel 2 (Printer)

Configuration Step	Values Set	Description
C3.5	RP	Remote Printer – Available on channel 1 only. This setting will behave as a Main Operation Unit that will redirect all printings to a Remote Printer (attached to the secondary unit) by using the Print Format setting in C3.6 and requires the secondary unit to be setup as a Remote Operation Unit. (C1.1 “DPM”=ROP)
C3.6	PFM	Print Format
	D	Disable Printing
	SIN	Single Line Format (Gross, Tare, Net Wt.)
	MUL	Multi-Line Print Format
	CON	Continuous Print Format (<STX>XXXXX.XX<SP>lb<ETX>) <STX> = Start of Text, <SP> = Space, <ETX> = End of Text
	CCO	Custom Continuous Print Format (Editable at C10.2)
	CPR	Custom Print Format (Editable at C10.1)
	RDP	Remote Display Format. This setting sets this unit to be a remote master and requires secondary display to be setup as the Remote Display (C1.1 “DPM” = RDP)
For C3.5 “TYP”=RP, only D, SIN, MUL or CPR choices are available		
C3.7	PRM	Print Mode
	P	Manually Print by pressing PRINT key
	S	Auto Print
	RP	Single manual print. A re-arming weight change will be necessary to enable subsequent prints
	RS	Auto Print. Auto print again after re-arming weight change.
	HP	Manual Print and hold display
	HS	Auto Print and hold display
	HRP	Manual Print and hold display. Print again after a re-arming weight change
	HRS	Auto Print and hold display. Print again after a re-arming weight change
	CON	Continuous Printing (requires setting of C3.6 = CON or CCO)
C3.8	MIN	Minimum Print Value Setting (In terms of Divisions)
	0~255	(Default = 0) Minimum printable weight in divisions
		The weight must be equal to or greater than this many divisions to enable printing
		With MIN=0 and Print Mode C3.7 PRM=P or HP, multiple manual prints can be performed without a requirement to unload the scale

Configuration Setup	Values Set	Description
C3.9	CHW	Re-arm weight in divisions Re-arming weight for print modes requiring a re-arm weight change. (C3.7=RP, RS, HRP or HRS)
	0~255	Default Value = "0"
C3.10	TMO	Print Response Retry Time-out for the bi-directional Remote Printer Communication This choice is only available when setting C3.5 "TYP"=RP
	0	Disable (Use Internal Default Retry Time-out)
	1~255	1=10 milliseconds (Should be at least 5=50ms)
C4	Filter/Motion	
C4.1	AVG	Average, Digital Filter
	1 ~ 8	Default = 4 (8 = Maximum Stability)
C4.2	MOW	Motion Window (1 = 0.5 Division)
	0~255	0 = No Motion Check Default = 1
C4.3	MOT	Motion Time (1 = 0.1 sec)
	0~255	Default = 5
C5	Pre-calibration	
C5.1	CUN	Calibration Unit Selection
	KG	To Calibrate by kilogram "kg"
	LB	To Calibrate by pound "lb"
	G	To Calibrate by gram "g"
	OZ	To Calibrate by ounce "oz"
C5.2	SUN	Secondary Conversion Weight Unit
	KG	To set secondary weight unit as kilogram "kg"
	LB	To set secondary weight unit as pound "lb"
	G	To set secondary weight unit as gram "g"
	OZ	To set secondary weight unit as ounce "oz"
C5.3	MET	Metrology Method
	OIML	OIML (F.S. Capacity + 9 divisions, 2% Zero Range, etc.)
	USA	USA (F.S. Capacity + 5%, 100 % Zero Range, etc.)
C5.4	DP	Decimal Point Position
	0 ~ 4	Default = 0, (No Decimal Point)
C5.5	CAP	Capacity Setting
	Display will show "C XXX.XX", Default = 50000 lb	
C5.6	DIV	Count-by
	1, 2, 5, 10, 20, 50, 100	Default = 1.
		Select any one of 1, 2, 5, 10, 20, 50 and 100.

Configuration Setup	Values Set	Description
C5.7	AZT	Auto Zero Tracking Width (In Divisions)
	OFF	Auto Zero Tracking function is OFF
	0.5D	Select any one of 0.5D through 3.0D
	To	
	3.0D	

C6	Calibration	
C6.1	REF	Calibration Mode
	RC	Standard Calibration (Zero Calibration and Span Calibration)
	RS	Span Calibration Only
	RO	Zero Calibration Only
C6.2	PCAL	Zero Calibration
	Display will show PCAL about 1 sec then " R XXXX.XX "	
	Insure the scale is unloaded and press 'Enter'	
C6.3	CAL	Span Calibration
	Display will show " CAL " about 1 sec then " N XXXX.XX "	
	Key in weight value to be used for Span Calibration (VC202 & VC203)	
	Scroll in the weight value to be used for Span Calibration (VC201)	
	Place the Weight on the scale and press 'Enter'	
	Press Enter key to save the Calibration when "End" is displayed	
C7	Calibration Tune	
C7.1	TUN	Tune Calibration (Adjust Span)
	0~255	1 = 0.1 times the current value of the one division
C7.2	DIR	Tune Direction
	UP	Adjust span upward
	DOWN	Adjust span downward
(VC202 & VC203 Only) To Enter the Custom Print Format Procedure With the C1 category displayed press 'Shift' then '0'		
C10	Custom Print Formats (See details in the Customizing Print Format section)	
C10.1	'P1 CUST'	Edit the Custom Print Format
	'P2 CONT'	Edit the Custom Continuous Print Format
C10.3	'FMT END'	Quit Print Format

Calibration Audit Trail

The audit trail consists of two event counters, one for the adjustment (calibration) parameters (audit trail 1) and one for configuration parameters (audit trail 2). The range will be (000 to 999) for each counter.

To view the audit counters press the 'G/N' and 'Enter' keys at the same time while the instrument is in the normal weighing mode. The audit trail will be displayed as long as the keys are held.

If the calibration jumper is installed the audit trail will be displayed momentarily before the password prompt.

The audit trail format will be:

XXXX.YYY where:

XXX is audit trail 1 and YYY is audit trail 2.

Audit trail one will increment when changes are made to:

Pre-calibration data

Calibration

Calibration Tune

Audit trail two will increment when changes are made to:

Filter settings

Print related settings C3.6-C3.9,

Print Format

Weight related operation keys such as Tare mode

Input/Output Connections

Pin-Out Reference Table of HD1	
<i>HD1 is a 10-Pin Single Inline Header providing a Zero and 2-Set Point Outputs,</i>	
Each output can provide maximum continuous sinking current of 20mA from an internal +5VDC power supply (Pin No. 9/10) or 50mA with an external +5VDC power supply. These outputs are intended to drive Solid State Relays, driving mechanical relays may present electrical interference problems	
Pin No. 1	Reserved
Pin No. 2	Reserved
Pin No. 3	Reserved
Pin No. 4	Set point # 2 Output
Pin No. 5	Set point # 1 Output
Pin No. 6	Zero Output
Pin No. 7	Ground
Pin No. 8	Ground
Pin No. 9	+ 5VDC
Pin No. 10	+ 5VDC

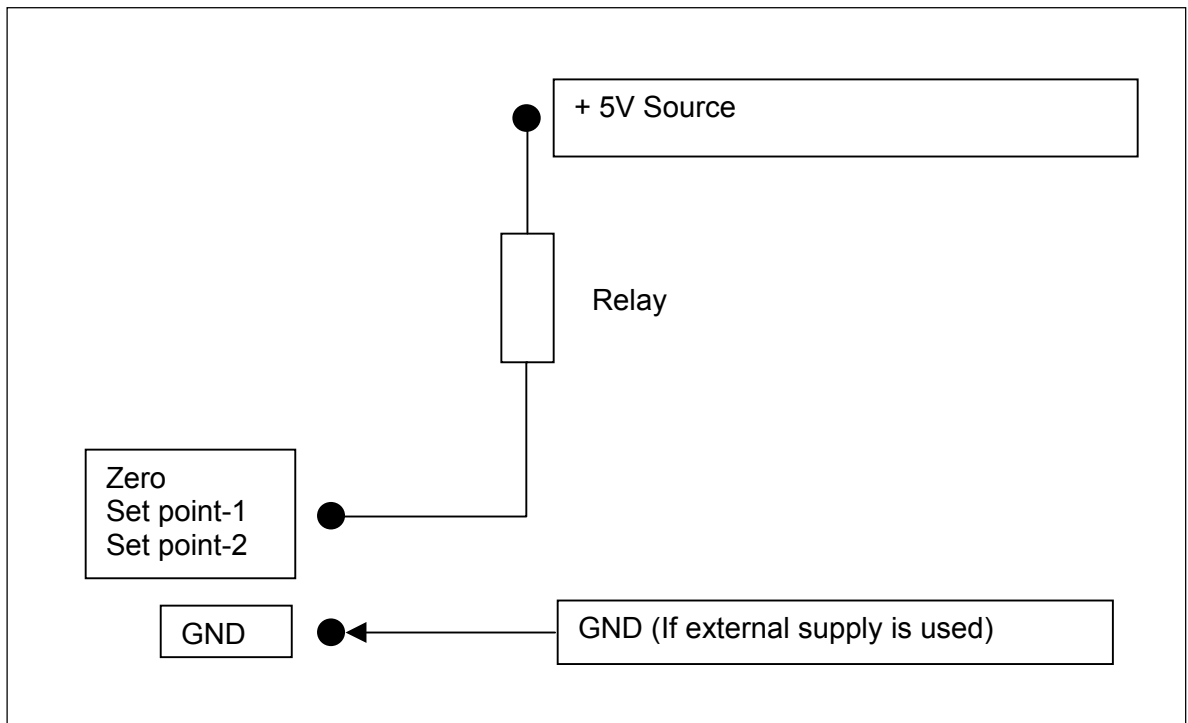

Pin-Out Reference Table of HD2	
<i>HD2 is a 5-Pin Single Inline Header used for RS232-C Communication</i>	
Pin No. 1	TxD (Transmit Data RS-232C Communication Channel 1)
Pin No. 2	RxD (Received Data RS-232C Communication Channel 1)
Pin No. 3	Com (Signal Ground RS-232C Communication Channel 1)
Pin No. 4	Com (Signal Ground RS-232C Communication Channel 2)
Pin No. 5	TxD (Transmit Data RS-232C Communication Channel 2)

Pin-Out Reference Table of TB1	
<i>TB1 is a 5 Pin Screw Terminal used for the Load Cell Connection</i>	
Pin No. 1	+Excitation
Pin No. 2	+Signal
Pin No. 3	- Signal
Pin No. 4	- Excitation
Pin No. 5	Shield

Pin-Out Reference Table of TB2	
<i>TB2 is a 3 Pin Terminal Block used for the AC Supply Voltage Connection</i>	
Pin No. 1	AC Voltage Supply wire from step-down transformer
Pin No. 2	AC Voltage Supply wire from step-down transformer
Pin No. 3	Earth Connection

Pin-Out Reference Table of TB3	
<i>TB3 is a 2 Pin Terminal Block for DC Supply Voltage Connection to a Battery</i>	
Pin No. 1	+12VDC Supply from Battery
Pin No. 2	0VDC Supply from Battery

[Jumpers, Headers and Terminal Blocks Location](#)

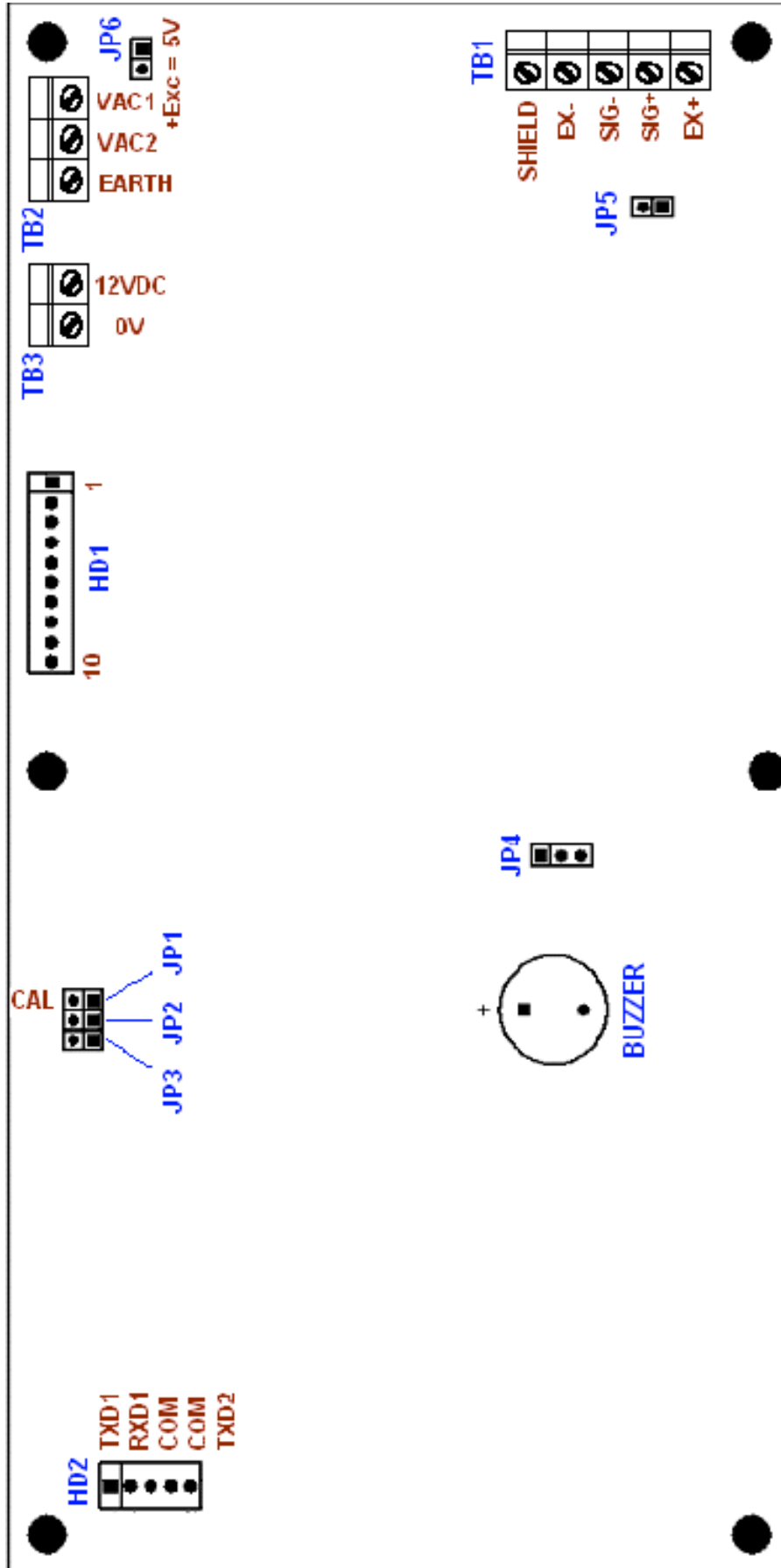

Error Messages

Error Messages Explanation	
CAP OL	Over Capacity, weight value exceeds the full scale capacity
ADC UL	Input load cell signal is too low or reversed, load cell or load cell-cable is faulty
ADC OL	Input load cell signal is too high, load cell or load cell-cable is faulty
NOT CAL	Scale is Not yet Calibrated
RMT DSP	Will be displayed on Remote Display Unit when there is no signal from the Main Display
RMT OPE	Will be displayed on Remote Operation Unit when there is no signal from the Main Display
SPAN OL	Maximum calculated span count is greater than maximum ADC Chip count
LO BAT	Insufficient battery voltage level. Need to re-charge the battery
-----	Display if Power On Zero fails. Need to unload the scale or optional press Zero Key if power on zero weight is within allowable zero range
S.TOTAL	Displayed before entering the password if Sub Total printing is pending. Need to press 'Shift'+ 'Print' to print the Sub Total and 'Shift'+ 'G/N' to print the Grand Total
G.TOTAL	Displayed before entering the password if Grand Total printing is pending. Need to press 'Shift'+ 'G/N' to print the Grand Total

Jumper Settings

Reference Table For Jumpers	
JP-1	Calibration Enable
JP-2	Reserved
JP-3	Not in use
JP-4	Not in use
JP-5	Not in use
JP-6	to set Excitation Voltage to 5V (Use to conserve power during battery operation)

Customizing Print Format (Optional)

- Press [**G/N**] key and [**Select/Enter**] key together, Audit Trail will be displayed, when released the display will show [**P 0**] and the 7th LED will flash, which means you need to enter the numeric value password to access the setup mode.
- Key in the password [**2**] [**0**] [**0**] [**1**] and press [**Enter**], the display will show [**C1**]
- Press [**Shift**] then [**0**], [**PRT FMT**] will be displayed, then [**P1 CUST**] will be displayed.
Here you can use the [**PRINT**] key or [**G/N**] key to browse the following three menus,
 - (1) [**P1 CUST**] ➤ For Custom Print Formatting.
 - (2) [**P2 CONT**] ➤ For Custom Formatting for Continuous Output.
 - (3) [**FMT END**] ➤ to end the Custom Formatting and return to normal weighing mode. select the menu by pressing the Enter key and continue the setting.
- The numeric characters (0, 1, ... , 9), all alphabets (A, B, ... , Z) and some other characters are already assigned to the Group-B keys (Ref: Key Explanation page as describe earlier) so these characters can be keyed in directly from Group-B keys. (Example: for "1" ➤ press [**1**] key,
for "A" ➤ press [**Shift**] then press [**2**] key,
for "B" ➤ press [**Shift**] then press [**2**] and press [**Shift**] key.
To confirm character entry, press [**Enter**] key after selecting the input character).
- *There will be a blinking LED just below one of the 7-segment display digits which shows the active digit position or character insertion position.*
- The characters or text to be printed out should be placed inside the double quotation marks.
(e.g. "FlexWeigh" will print out as FlexWeigh)
- For Control characters or some other characters which cannot be used by the front panel keys are to be keyed in by using the following format:
"xxx" (where: xxx is the ASCII code or extended ASCII code (0~255) in decimal value of the character code to be printed)
- **Following Command Codes are provided:**
 - (1) "\R" = Carriage Return
 - (2) "\N" = Line Feed
 - (3) "\E" = End of line (CR+LF) (e.g. "\E" = "\R\n" will be printed)
 - (4) "\Lx" = "x" Line Feeds (e.g. "\L3" = "\N\n\n" = 3 Line Feeds will be printed)
 - (5) "\Sx" = "x" Spaces (e.g. "\S4" = 4 spaces will be printed)
 - (6) "\CX.Y" = Repeat printing a character X for a total of Y characters, X can be "xxx" form (e.g. "\C=.16" = Prints "=" for 16 characters or "\C\42.16 = Prints "*" for 16 characters)
- **Weight Format Command (WX.Y)**
X = Weight Type (0 = Net, 1 = Gross, 2 = Tare)
Y = Field Width (Includes "." if any)
- **Weight Unit Command (U)**
Appends the current unit of measurement to the printed weight and optional tare entry flag.
 - (1) "^kg^^^" For Pushbutton Tare, Gross or Net Weight. (kg = current unit, ^ = space)
 - (2) "^kg(K)" For Keyboard Tare or Recall Tare Weight.

- **Delay Command (DX)**
Delay after print which is normally placed after CR/LF, where **X** = Delay Time
(1 = 0.1 sec).
- ❑ **Example: W1.8U** = Print the gross weight right justified with a field width of 8 followed by the current units: e.g. “ **3456.78 kg** ”
- To **Print** the current editing print format press [**Tare**] key then select [**Print**].
- To **Erase** the current editing print format press [**Tare**] key then select [**Erase**].

Print Output Formats & Printout Samples

❑ **Single Line Print Output Format (C3.6 = SIN)**

Gross^XXXXXXXX^kg^^^^Tare^XXXXXXXX^kg^^^^Net^XXXXXXXX^kg<NL>

Where: ^ = Space, X = Number ('0' to '9') or Leading Space or Decimal Point or Minus

Single Line Format Output Sample

Gross	29.999 kg	Tare	9.999 kg	Net	20.000 kg
Gross	3000.00 lb	Tare	5.00 lb(K)	Net	2995.00 lb
Gross	22000 kg	Tare	2000 kg	Net	20000 kg

❑ **Multi-Line Print Output Format (C3.6 = MUL)**

Gross^XXXXXXXX^kg^^^<NL>^Tare^XXXXXXXX^kg^^^<NL>^^Net^XXXXXXXX^kg^^^<2xNL>

Multi-Line Format Print Output Sample

Gross	30.000 kg
Tare	10.000 kg
Net	20.000 kg

Gross	30.000 kg
Tare	10.000 kg(K)
Net	20.000 kg

❑ **Continuous Print Format (C3.6 = CON)**

<STX>XXXXXX.XX^kg^^^<ETX>

❑ **Default Custom Print Format Sample (C3.6 = CPR)**

"GROSS\58\S3"W1.8U"R\N TARE\58\S3"W2.8U"R\N NET\58\S3"W0.8U"R\L2"

Corresponding Print Output is:

Gross:	30.000 kg
Tare:	10.000 kg
Net:	20.000 kg

Gross:	30.000 kg
Tare:	10.000 kg(K)
Net:	20.000 kg

❑ **Default Custom Continuous Print Format Sample (C3.6 = CCO)**

"\2"W0.8U"\3"

Corresponding Print Output is:

<STX>XXXXXX.XX^kg^^^<ETX>

❑ **Note:**

A '(K)' is printed after a keyboard entry or recalled tare weight.

Journal Print Format & Printout Sample

Journal Print Format is enabled by the settings: 1) Custom Print Format Type (**C3.6** "PFM" = CPR) with the proper Journal Print Format in **C10.1** as will be described below, 2) Date/Time Setup Enable (**C1.4** "DTM" = E) and 3) Journal Print Feature Enable (**C1.5** "JPR" = E) .

Following commands are specially provided for Journal Printer Print Formats:

➤ **Journal Print Format Commands (FX)**

Where X = Format No. 1 to 5.

Each of the following command defines the format header or a start position of print format.

F1 = Start of Main Title Format

F2 = Start of Sub Title Format

F3 = Start of Batch Weighing Format

F4 = Start of Sub Total Format

F5 = Start of Grand Total Format

Note: At the end of each format, "CR/LF" pair will be printed, except at the end of **F5**.

➤ **Code and Number Format Commands (NX)**

Where X = Format No. 1 to 4.

Each of the following command represents the Code or Numeric Data to be printed.

N1 = Product Code (10 Alpha-Numeric Characters)

N2 = Consecutive No. (5 Numeric Characters)

N3 = Sub Total Counts (5 Numeric Characters)

N4 = Grand Total Counts (5 Numeric Characters)

➤ **Weight and Unit Format Commands (WX.Y.U)**

X = Weight Type (**0** = Net, **1** = Gross, **2** = Tare,
3 = Sub Total Weight, **4** = Grand Total Weight).

Y = Field Width (Includes "." if any)

U = Appends the current unit of measurement to the weight and optional tare entry flag.

(1) **U = 0**: Not print current unit of measurement. (Same as W.X.Y)

(2) **U = 1**: Appends the current unit of measurement ("^kg") to the printed weight.

(3) **U = 2**: Appends as described in (2) but with 3 additional characters of tare

entry flag:

(a) "^^^" For Pushbutton Tare, Gross or Net Weight (^ = Space).

(b) "(K)" For Keyboard Tare or Recall Tare Weight.

❑ **Example:** Following will print the net weight right justified with a field width of 8 and will finally print a different type of optional current unit of measurement description:

W0.8.0 = without current unit: e.g. " **3456.78**" (same as W0.8).

W0.8.1 = 1 space and 2 characters of current unit: e.g. " **3456.78 kg**".

W0.8.2 = 1 space and 2 characters of current unit with 3 extra spaces of tare flag. e.g. " **3456.78 kg** " (same as W.0.8U).

➤ **Time Format Commands (TX)**

Where X = Time Format No. 1 to 8 as follows:

Command	Format	Print Out
T1	H:MM	2:13
T2	HH:MM	02:13
T3	H:MM AM/PM	2:13 AM
T4	HH:MM: AM/PM	02:13 AM
T5	H:MM:SS	2:13:00
T6	HH:MM:SS	02:13:00
T7	H:MM:SS AM/PM	2:13:00 AM
T8	HH:MM:SS AM/PM	02:13:00 AM

Command	Format	Print Out
H1	D/M/YYYY	2/3/2004
H2	D/M/YY	2/3/04
H3	DD/MM/YYYY	02/03/2004
H4	M/D/YYYY	3/2/2004
H5	M/D/YY	3/2/04
H6	MM/DD/YY	03/02/04
H7	MM/DD/YYYY	03/02/2004
H8	YY/MM/DD	04/03/02
H9	YYYY-MM-DD	2004-03-02
H10	D MMM YYYY	2 Mar 2004
H11	DD-MMM-YY	02-Mar-04
H12	DD-MMM-YYYY	02-Mar-2004
H13	DDD D MMM YYYY	Tue 2 Mar 2004

➤ **Date Format Commands (HX)**

Where X = Date
Format No. 1 to 13 as follows:

```

=====
VMC
=====
28/5/2004 13:18
CODE: 1234567890
  1   200.0 kg
  2   200.0 kg
-----
  2   400.0 kg

28/5/2004 13:20
CODE: ABC1234567
  1   400.0 kg
  2   200.0 kg
-----
  2   600.0 kg

TOTAL:                4
                1000.0 kg

```

☐ **Custom Journal Print Format Sample (C3.6 = CPR)**

Editable at C10.1 Custom Print Format as follow:

Main Title

- F1" \E\C=.16\E◦
- VMC\E◦
- \C=.16\E"◦

Sub Title

- F2H1T2" \E◦
- CODE: "N1◦

Batch Weighing

- F3N2W0.8.1◦

Sub Total

- F4" \C-.16\E"◦
- N3W3.8.1" \R\L2"◦

Grand Total

- F5" TOTAL:\S5"N4" \E"◦
- W4.13.1" \R\L4"◦

Note:

- ❖ The actual custom print format that will be shown inside the “**C10.1**” edit buffer is the continuous extraction of any characters located between the two delimited symbols “**o**” of the above multi-line print format sample.
- ❖ To quickly jump to the start of each format (**F1** to **F5**) during editing the custom print format, press [**Shift**] key then press [**>**] or [**<**] key to jump to the next or previous journal print format position respectively.
- ❖ The right figure shows the print output of the above custom journal print format sample.

Journal Print Format Key Operation

Following procedures are only available when the Custom Print Format contains the specific Journal Print Format as described in the previous section. It requires 3 main printing steps to complete the Operation, i.e. (1) Batch Weighing, (2) Sub Total and (3) Grand Total as follows:

How to print the Batch Weighing:

- 1) Before starting the first weighing of each new batch, enter the Product Code (10 alpha-numeric characters) by using the Function Key [F1] (Press [Shift] then press [1]).

Note:

- Enter the Product Code in the same way as editing the Custom Print Format in **C10.1**.
 - To **Delete** all characters of Product Code at once, press [Shift] then press [Clear].
 - The Function Key [F1] is automatically enabled when the Sub Title Format (**F2**) contains the Product Code (**N1**) command.
- 2) Perform a consecutive batch weighing as usual, i.e. when the weight becomes stable, either Manually Print or an Auto Print should be issued depending on the setting in **C3.7** "PRM". Following conditional print formats will be printed:
 - (i) **Main Title Print Format (F1):**
Printed only once at the start of the **First Batch Weighing**. Normally the Company Name is printed here.
 - (ii) **Sub Title Print Format (F2):**
Printed only once at the start of each **New Batch Weighing**. Normally Date/Time and Product Code is printed here.
 - (iii) **Batch Weighing Format (F3):**
Once the above two conditional formats are printed, each weighing in a batch will be printed consecutively. Normally Consecutive No. and Net Weight with current selected unit are printed here. After printing, the following data will be updated:
 - a) Consecutive No. (**N2**) will be increased by one.
 - b) Sub Total Count (**N3**) will be increased by one.
 - c) The Printed (Net) Weight (**W0**) will be accumulated to the Sub Total Weight (**W3**)
 - 3) Continue the next consecutive weighing as described in step (2.iii) if required.
 - 4) For the last Batch Weighing, issue the Sub Total Data Print as shown below.

How to print the Sub Total:

After printing the last weighing of each batch, issue the Sub Total Data Print as follows:

- 1) Press [Shift] then press [Print].
- 2) The **Sub Total Print Format (F4)** Data will be printed. Normally line separator, Sub Total Data e.g. Accumulated Counts (**N3**) and Accumulated Weight (**W3**) will be printed here.
- 3) After printing the Sub Total Data, the following will be reset:
 - a) Consecutive No. (**N2**) will be reset to one.
 - b) Sub Total Count (**N3**) will be cleared to zero
 - c) Sub Total Weight (**W3**) will be cleared to zero.
- 4) Continue the next batch with the above **How to print the Batch Weighing** if required.
- 5) For the last batch Sub Total printing, issue the Grand Total Data Print as shown below.

How to print the Grand Total:

After the last batch Sub Total Data Print, issue the Grand Total Data Print as follows:

- 1) Press [**Shift**] then press [**G/N**].
- 2) The **Grand Total Print Format (F5)** Data will be printed. Normally Grand Total Data e.g. Accumulated Counts (**N4**) and Accumulated Weight (**W4**) will be printed here.
- 3) After printing the Grand Total Data, the following will be reset:
 - a) Grand Total Count (**N4**) will be cleared to zero
 - b) Grand Total Weight (**W4**) will be cleared to zero.
- 4) Restart the new Operation with the above “**How to print the Batch Weighing**” if required.

Note:

- ❖ When the Batch Weighing Operation is in process, the Print LED lamp will be always turned ON to indicate that the Sub Total data or the Grand Total data is pending.
During in this period, the following Operations are temporary **disabled**:
 - **Unit Key Toggle** is disabled
 - **Configuration Setup** is disabled
- ❖ After printing the Sub Total and Grand Total data, the Print LED lamp will be turned OFF, the Operations of Unit Key Toggle and Configuration Setup will be enabled again.

[Date and Time Settings Operation](#)

Date and Time Settings can be enabled with the configuration setting in **C1.4** “DTM” = “E”. If enabled, the following description explains how to setup the Date and Time operation.

Once the power on count down has finished; the date and time settings procedure will be prompted to allow the operator to enter the current date and time that can be printed out by the custom date or time formats defined in the editable custom print format at **C10.1**.

These date and time formats are specially provided for a journal print format to print the current date and time, normally as a part of the Sub Title before the starting of each batch weighing.

The date or time data is generated from the system clock of the indicator. As long as the indicator is on, the internal clock will keep running and automatically support the calendar features as follows:

- Number of days in each month.
- Day of week (e.g. Sun, Mon, Tue, Wed, Thu, Fri, Sat)
- Leap year (The year with 29 days in February)

How to setup the current Date and Time:

The following are the sequence of date and time setups, just after the display count down finished:

After “DATE” displayed about 1 second, enter the current date as follows:

LED Display	Description	Data Range
YRS XX	Enter the current Year	XX = 00 to 67 for Year = 2000 to 2067
MON XX	Enter the current Month	XX = 1 to 12
DAY XX	Enter the current Date	XX = 1 to 31

After “TIME” displayed about 1 second, enter the current time as follows:

LED Display	Description	Data Range
HRS XX	Enter the current Hour	XX = 0 to 23 (Setup as 24 Hour Format)
MIN XX	Enter the current Minute	XX = 0 to 59
SEC XX	Enter the current Second	XX = 0 to 59

How to momentarily display the current Date and Time:

During the normal weighing operation, press [**Shift**] then press [**Enter**]. The display will show the current time (5 seconds) then will show the current date (3 seconds) as shown in the following formats:

- **Current Time Format “HH.MM.SS”**
Where: HH = Hour, MM = Minute, SS = Second
- **Current Date Format “DD.MM.YY.W”**
Where: DD = Day, MM = Month, YY = Year,
W = Day of week (0 = Sun, 1 = Mon, 2 = Tue, 3 = Wed, 4 = Thu, 5 = Fri, 6 = Sat)

Setup Record Table			
Owner	>		
Scale Model	>	Firmware Version	>
Serial Number	>	Date of Purchase	>
Capacity & Division	>	Setup Date	>
Application Type	>		
Load cell Brand & Model	>	Load cell Capacity	>
No. of Load cell	>	Load cell Sensitivity	>
C1.1 > Display Mode	>	C1.2 > Hot-key	>
C1.3 > Auto-Power Off	>	C1.4 > Date-Time Enable	>
C1.5 > Journal Print	>		
C2.1 > Unit Key Toggle	>	C2.2 > Tare key mode	>
C2.3 > Tare key at zero	>	C2.4 > Preset 1 Enable	>
C2.5 > Preset 2 Enable	>		
C3.1 > Instrument	>		
RS-232C Communication Channel 1 Settings		C3.3 > Ch-1 Baud Rate	>
C3.4 > Ch-1 Parity	>	C3.5 > Ch-1 Type	>
C3.6 > Ch-1 Print Format	>	C3.7 > Ch-1 Print Mode	>
RS-232C Communication Channel 2 Settings		C3.3 > Ch-2 Baud Rate	>
C3.4 > Ch-2 Parity	>	C3.5 > Ch-2 Type	>
C3.6 > Ch-2 Print Format	>	C3.7 > Ch-2 Print Mode	>
C3.8 > Minimum Print	>	C3.9 > Wt.Change	>
C3.10 > Print Retry Time-	>		
C4.1 > Average	>	C4.2 > Motion Window	>
C4.3 > Motion Time	>	C5.1 > Calibration Unit	>
C5.2 > Secondary Unit	>	C5.3 > Metrology	>
C5.4 > Decimal Point	>	C5.5 > Capacity	>
C5.6 > Division size	>	C5.7 > Auto Zero	>
C10.1 > P1 CUST			
C10.2 > P2 CONT			
Set point 1, Start Value		Set point 1, End Value	
Set point 2, Start Value		Set point 2, End Value	
REMARKS			

Display Character Reference

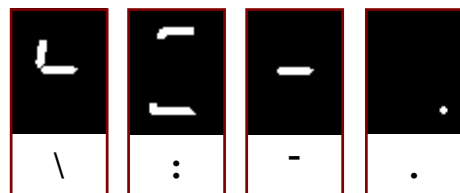
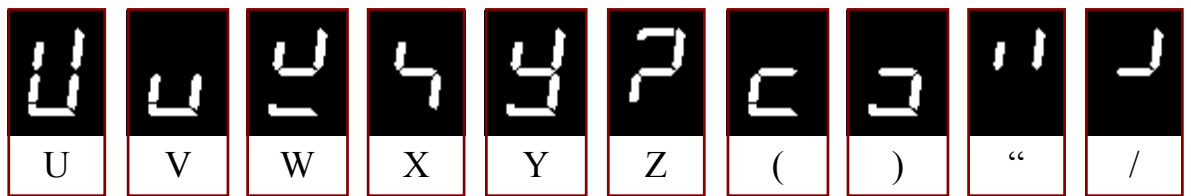
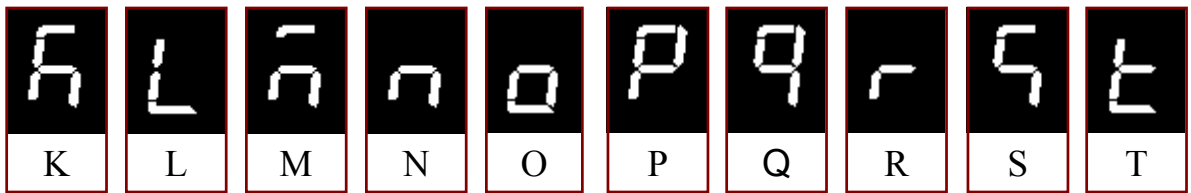
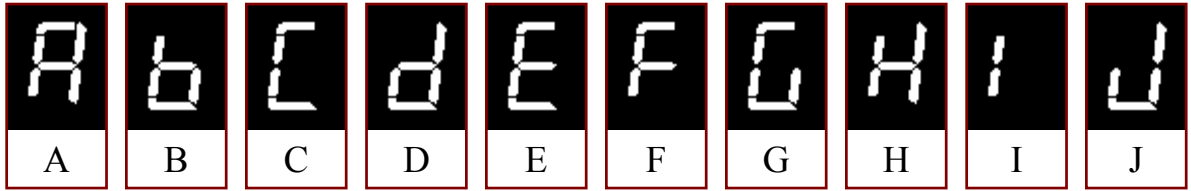
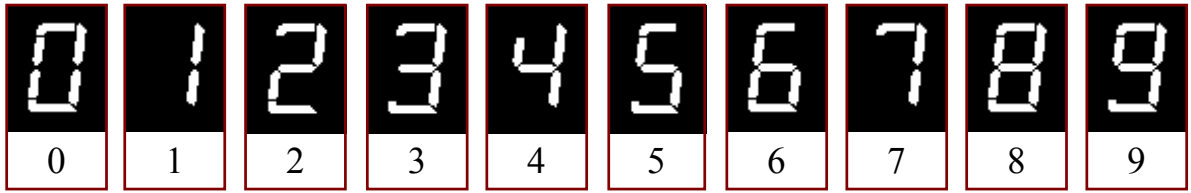

ASCII Character Set

ASCII Character Set											
Dec	Hex	Char	Dec	Hex	Char	Dec	Hex	Char	Dec	Hex	Char
0000	00	NUL	0032	20	SP	0064	40	@	0096	60	`
0001	01	SOH	0033	21	!	0065	41	A	0097	61	a
0002	02	STX	0034	22	"	0066	42	B	0098	62	b
0003	03	ETX	0035	23	#	0067	43	C	0099	63	c
0004	04	EQT	0036	24	\$	0068	44	D	0100	64	d
0005	05	ENQ	0037	25	%	0069	45	E	0101	65	e
0006	06	ACK	0038	26	&	0070	46	F	0102	66	f
0007	07	BEL	0039	27	'	0071	47	G	0103	67	g
0008	08	BS	0040	28	(0072	48	H	0104	68	h
0009	09	HT	0041	29)	0073	49	I	0105	69	i
0010	0A	NL	0042	2A	*	0074	4A	J	0106	6A	j
0011	0B	VT	0043	2B	+	0075	4B	K	0107	6B	k
0012	0C	FF	0044	2C	,	0076	4C	L	0108	6C	l
0013	0D	CR	0045	2D	-	0077	4D	M	0109	6D	m
0014	0E	SO	0046	2E	.	0078	4E	N	0110	6E	n
0015	0F	SI	0047	2F	/	0079	4F	O	0111	6F	o
0016	10	DLE	0048	30	0	0080	50	P	0112	70	p
0017	11	DC1	0049	31	1	0081	51	Q	0113	71	q
0018	12	DC2	0050	32	2	0082	52	R	0114	72	r
0019	13	DC3	0051	33	3	0083	53	S	0115	73	s
0020	14	DC4	0052	34	4	0084	54	T	0116	74	t
0021	15	NAK	0053	35	5	0085	55	U	0117	75	u
0022	16	SYN	0054	36	6	0086	56	V	0118	76	v
0023	17	ETB	0055	37	7	0087	57	W	0119	77	w
0024	18	CAN	0056	38	8	0088	58	X	0120	78	x
0025	19	EM	0057	39	9	0089	59	Y	0121	79	y
0026	1A	SUB	0058	3A	:	0090	5A	Z	0122	7A	z
0027	1B	ESC	0059	3B	;	0091	5B	[0123	7B	{
0028	1C	FS	0060	3C	<	0092	5C	\	0124	7C	
0029	1D	GS	0061	3D	=	0093	5D]	0125	7D	}
0030	1E	RS	0062	3E	>	0094	5E	^	0126	7E	~
0031	1F	US	0063	3F	?	0095	5F	_	0127	7F	DEL